

# Flex Network High Speed Counter Unit Installation Guide

Thank you for purchasing Pro-face's "Flex Network High Speed Counter Unit" (FN-HC10SK41). To ensure correct use of this unit's functions and features, be sure to carefully read both this Installation Guide and the Flex Network High Speed Counter Unit User Manual.

## Safety Precautions

### DANGER

- An emergency stop circuit and an interlock circuit should be constructed outside of this unit. Constructing these circuits inside this unit may cause a runaway situation, system failure, or an accident due to unit failure.
- Systems using this unit should be designed so that output signals which could cause a serious accident are monitored from outside the unit.
- This unit is designed to be a general-purpose device for general industries, and is neither designed nor produced to be used with equipment or systems in potentially life-threatening conditions. If you are considering using this unit for special uses, including nuclear power control devices, electric power devices, aerospace equipment, medical life support equipment, or transportation vehicles, please contact your local Flex Network distributor.

### WARNING

- Whenever installing, dismantling, wiring, and conducting maintenance or inspections, be sure to disconnect power to this unit to prevent the possibility of electric shock or fire.
- Do not disassemble or modify this unit, since it may lead to an electric shock or fire.
- Do not use this unit in an environment that contains flammable gases since it may cause an explosion.
- Do not use this unit in an environment with conditions outside of the ranges specified in this Installation Guide and in the User Manual. Otherwise, an electric shock, fire, malfunction or other failure may occur.
- Because of the possibility of an electric shock or malfunction, do not touch the power terminals while the unit is operating.

### CAUTION

- Communication cables or I/O signal lines must be wired separately from the main circuit (high-voltage, high-current) line, high-frequency lines such as inverter lines, and the power cord. Otherwise, a malfunction may occur due to noise.
- This unit must be properly installed according to directions in the Installation Guide and User Manual. Improper installation may cause the unit to malfunction, or operate incorrectly.
- This unit must be properly wired according to directions in the Installation Guide and User Manual. Improper wiring may cause a unit malfunction, failure or electric shock.
- Do not allow foreign substances, including chips, wire pieces, water, or liquids to enter inside this unit's case. Otherwise, a malfunction, failure, electric shock, or fire may occur.
- When disposing of this unit, it should be disposed of according to your country's industrial waste disposal laws.

### To Prevent Unit Damage

- Do not store or operate this unit in either direct sunlight or excessively dusty or dirty environments.
- Since this unit is a precision instrument, do not store or use it in locations where excessive shocks or vibration may occur.
- Do not block this unit's ventilation holes, or operate it in an environment that may cause it to overheat.
- Do not operate this unit in locations where sudden temperature changes can cause condensation to form inside the unit.
- Do not use paint thinner or organic solvents to clean this unit.

## Safety Standards

### UL/c-UL (CSA)

The FN-HC10SK41 is a UL/c-UL (CSA) listed product. (UL file No. E220851)

This unit conforms to the following standards:

- UL 508 Industrial Control Equipment
- CAN/CSA C22.2 No.1010-1 MEASUREMENT AND CONTROL EQUIPMENT (Safety requirements for electrical equipment for measurement and laboratory use)

FN-HC10SK41 (UL Registration Model: 2980051-01)

### <Cautions>

- The FN-HC must be a built-in component of an end-use product.

- If the FN-HC is mounted so as to cool itself naturally, be sure to install the unit in a vertical (upright) panel, using either a DIN rail, or the installation screw holes.

- The power unit attached to the FN-HC should be a UL/c-UL (CSA) approved Class 2 power unit, or a Class 2 transformer.\*1

If a single power supply is used to power the GLC/LT/GP3000, or multiple Flex Network units, design the wiring so the sum of the Flex Network unit's consumption current and the total load current does not exceed the Class 2 power unit or the Class 2 transformer's rating.

*\*1 A Class 2 power unit/Class 2 transformer provides 30V output at 8A or less, at 100V or less. (defined by National Electrical Code)*

### CE Marking

The FN-HC10SK41 is a CE marked product that conform to EMC directives EN55011 class A and EN61000-6-2. For detailed CE Marking information, please contact your Flex Network distributor.

## Package Contents

- Flex Network High Speed Counter Unit (FN-HC10SK41)
- Flex Network High Speed Counter Unit Installation Guide (this guide)

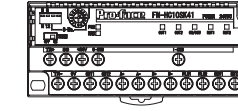

## Driver & Manual

The driver for the Flex Network Unit is required in order to use the unit.

For GLC2000 Series and LT Series, You can select the Flex Network Driver via GP-PRO/PBIII C-Package (Pro-Control Editor) or LT Editor.

If the selection of the appropriate unit's name does not appear in the [I/O Configuration] - [I/O Unit Settings] area, you will need to update the driver file.

You can download the latest driver from Pro-face's Home Page. For GP3000 Series, You can select the Flex Network Driver via GP-Pro EX as an I/O driver.

Also, you can download the driver and the Flex Network High-Speed Counter Unit User Manual from Pro-face's web site. (<http://www.pro-face.com/>)

## 1 External Dimensions / Part Names

This section shows the external dimensions of the high speed counter unit, part names and part settings.

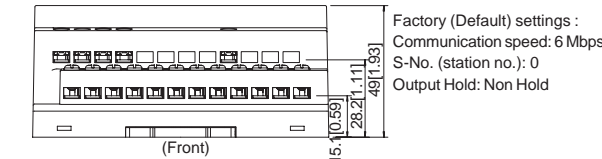
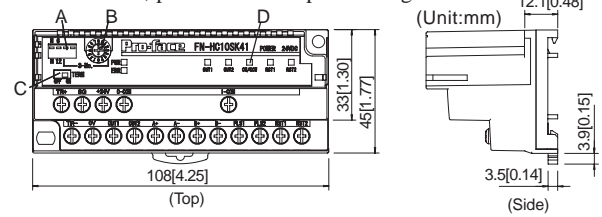

Factory (Default) settings :  
Communication speed: 6Mbps  
S-No. (station no.): 0  
Output Hold: Non Hold

- A: Dip Switches ..... Set communication speeds and S-No. (first digit).
- B: S-No. (station no.) Switch ..... Sets S-No. (last digit).
- C: Terminator ..... Switches termination ON/OFF. Turns ON the units at both ends of the communication cable.
- D: Status LED ..... Indicates the unit's current operation status.

### Switch Settings

- SW1 N ..... Non Hold (Resets count value and all outputs)  
H ..... Hold (Holds count value and current outputs)
- SW2 6 ..... 6Mbps  
12 ..... 12Mbps
- SW3,4 Upper ..... ON(1)  
Lower ..... OFF(0)
- Arrow tip ..... Setting values (0 to F)
- OFF ..... Termination OFF  
ON ..... Termination ON

### Examples of S-No. (station no.) settings

S-No.	Dip Switch		S-No. (Station no.)
	SW3	SW4	
	OFF(0)	ON(1)	0
10h(16)			
3Fh(63)	ON(1)	ON(1)	F

**Important** When the Logic Program changes from the RUN condition to either OFFLINE mode or RESET, all GLC/LT/GP3000 and external outputs will be performed as shown below, regardless of the Output Hold Setting. Be sure to consider this when changing to either the OFFLINE or RESET modes.

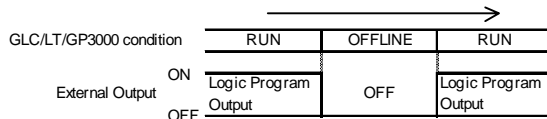

However, when using the RESET command, the timing of the external output OFF timing is not fixed and can vary.

## 2 Specifications

### Electrical (Control Section)

Rated Voltage	DC24V
Rated Voltage Range	DC20.4 to DC28.8V
Allowable Voltage Drop	Up to 10ms (power supply: DC24V)
In-Rush Current	15A or less
Power Consumption	2.5W or less
Voltage Endurance	AC500V 20mA 1 minute (between input/output and earth terminals)
Insulation Resistance (via noise simulator)	10MΩ or more at DC500V (between input/output and earth terminals)

### Environmental

Ambient Operating Temperature	0°C to 55°C
Ambient Storage Temperature	-25°C to +70°C
Ambient Humidity	30% RH to 95% RH (no condensation)
Rating	IP20

### Input/Output Specifications

Input Type	Differential Input (line driver)	DC Input (DC24V Open collector)
Rated Input Voltage	DC5V	DC24V
Max. Input Voltage	DC4.5V to DC5.5V	DC26.4 V
Calculated Speed (Rise and Fall time)	$t_r=0.5\mu s$ or less (200kpps)	$t_r=10\mu s$ or less (10kpps)
Min. Pulse Width	$5\mu s$	$100\mu s$
Phase	90° phase differential 2-phase signal, 1 phase + directional signal, 1 phase addition signal	
Input Impedance	470Ω	4.9kΩ
Input ON Voltage	EIA Standard RS-422-A	DC19V or higher
Input OFF Voltage	Differential Driver	DC5V or lower
Input OFF-ON Delay	(Equivalent to Texas Instruments SN75157)	Maximum: 1.5ms
Rated Output Voltage	DC24V	
Rated Output Voltage Range	DC24V (+/-10%)	
Output Voltage Drop	DC1.5V or lower	
Output Current	50mA or lower	
Output OFF-ON Delay	Maximum: 1ms	
Output ON-OFF Delay	Maximum: 1ms	
Short-circuit Protection	None	
Leakage Current	0.1mA or lower	

### Flex Network Communication Specifications

Number of Occupied Nodes	8
--------------------------	---

## 3 Connection Drawing

The following drawing shows the Flex Network High Speed Counter unit's connection wiring.

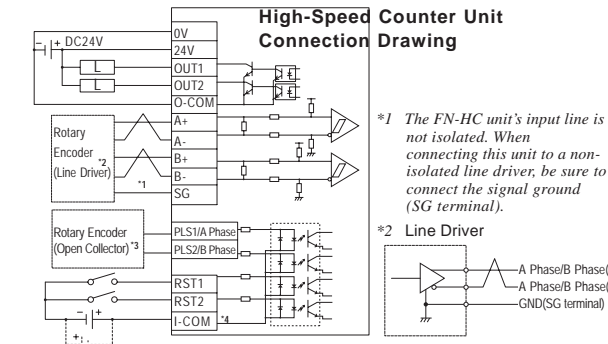

\*3 Open Collector (Sink Output) Open Collector (Source Output)



\*4 The Input Common (I-COM) shown here is connected to a Sink Output type. (The dotted line shows the connection with a Source Output type.)

Terminal Name	Feature	
TR+	Flex Network Communication	Communication
TR-	Flex Network Communication	Channel
+24V	Unit Power (DC24V)	Power
0V	Unit Power (DC0V)	
OUT1	Comparator Output (Counter 1) / Cam Switch 1 Output	Control Output
OUT2	Comparator Output (Counter 2) / Cam Switch 2 Output	
O-COM	Output Common	
+A	A Phase Differential Input +	Differential Input
-A	A Phase Differential Input -	
+B	B Phase Differential Input +	
-B	B Phase Differential Input -	
SG	Signal Ground	
PLS1	Counter 1 DC Input - A phase	DC Input
PLS2	Counter 2 DC Input - B phase	
RST1	Up/Down and Up Counter 1 Reset Signal	
RST2	Up Counter 2 Reset Signal*1	
I-COM	Input Common DC24V (with Source Output type connection: 0V)	

\*1 RST2 input is enabled only when input mode is (MODE1)

## 4 Installation

### Installing the FN-HC unit on a 35 mm DIN Rail:

#### Installation

Hook the analog unit's top face groove over the top edge of the DIN rail. Next, push the bottom of the I/O unit forward until the attachment hook clicks into place on the DIN rail.

#### Removal

Use a screwdriver to push the attachment hook down and release the unit. Then, pull the unit forward and off the rail.

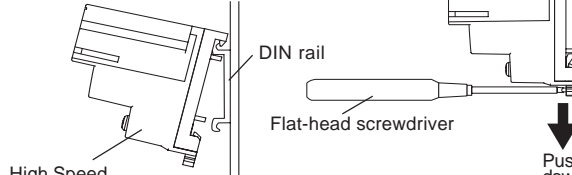

**Important** Be sure that the top and bottom faces of the unit are facing the correct direction and the unit is installed in a vertical position. Incorrect installation may cause overheating.

### Installing the FN-HC unit in a Panel:

Create screw holes with M4 size screws. Screw torque: max 1.0N•m

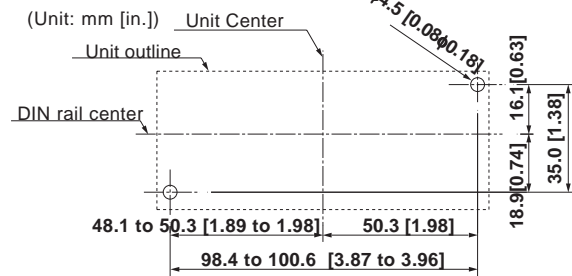

## 5 Wiring

This section describes both the cables and crimp terminals used for wiring each type of cable. The terminal screw torque should be 0.6 to 1.0 N•m. Up to 2 terminals can be connected.

### Communication Cable

The Flex Network interface unit and the Flex Network unit, or all distributed Flex Network units, are connected using a cross wiring system. (T-type systems cannot be used.) Pro-face suggests the following communication cables.

Distributor	Order Code	Length
Pro-face	FN-CABLE2010-31-MS	10m
	FN-CABLE2050-31-MS	50m
	FN-CABLE2200-31-MS	200m

When preparing the cable wire ends:

- Cover shielded wires with shield tape or with an insulation tube.
- Use insulated crimp terminal.
- If you use a pressure connection terminal without insulation, cover it with a shield tape or an insulation tube. Cover insulated crimp terminals with shield tape or a tube-type insulation.

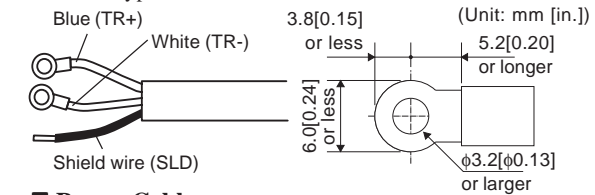

### Power Cable

- Cable diameter can be up to 1.25 mm<sup>2</sup>. Be sure to twist all wire ends before attaching crimp terminals.
- Use the same type crimp terminals as used for the communication cable.

### I/O Cable

- Cable diameter can be from 0.75 mm<sup>2</sup> to 1.25 mm<sup>2</sup>.
- Use the same type crimp terminals as used for the communication cable.

**Important** Confirm that all I/O unit terminal screws are securely tightened, even they are not used.

**Note** Please be aware that Digital Electronics Corporation shall not be held liable by the user for any damages, losses, or third party claims arising from the uses of this product.

Digital Electronics Corporation  
8-2-52 Nanko-higashi  
Suminoe-ku, Osaka 559-0031 JAPAN  
Tel: +81-(0)6-6613-1101  
Fax: +81-(0)6-6613-5888  
URL: <http://www.pro-face.com/>