

# OMRON

## MODEL **H5S** DIGITAL TIME SWITCH

# INSTRUCTION MANUAL

Thank you for purchasing this OMRON product. Please read this instruction MANUAL and thoroughly familiarize yourself with the functions and characteristics of the product before use. Please retain this MANUAL for future reference.

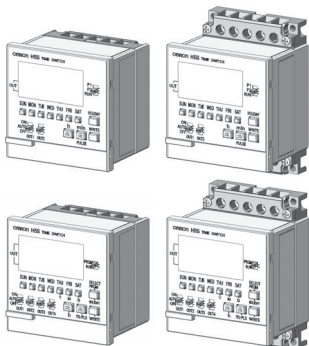

- Safety Precautions  
..... P.1
- Table of Contents  
..... P.5
- Operation  
..... P.9
- Installation  
..... P.60

**OMRON Corporation**

9966572-0B

© All Rights Reserved.

## Suitability for Use

OMRON shall not be responsible for conformity with any standards, codes, or regulations that apply to the combination of the products in the customer's application or use of the product.

Take all necessary steps to determine the suitability of the product for the systems, machines, and equipment with which it will be used.

Know and observe all prohibitions of use applicable to this product.

**NEVER USE THE PRODUCTS FOR AN APPLICATION INVOLVING SERIOUS RISK TO LIFE OR PROPERTY WITHOUT ENSURING THAT THE SYSTEM AS A WHOLE HAS BEEN DESIGNED TO ADDRESS THE RISKS, AND THAT THE OMRON PRODUCT IS PROPERLY RATED AND INSTALLED FOR THE INTENDED USE WITHIN THE OVERALL EQUIPMENT OR SYSTEM.**

See also Product catalog for Warranty and Limitation of Liability.

## Safety Precautions





### ● Key to Warning Symbols



**CAUTION**









Indicates information that, if not followed, could result in relatively serious or minor injury, property damage, or faulty operation.

## ● Graphic symbol

	● Warning against electric shock Notification of possible electric shock under certain conditions.
	● General warning Notification of general, unspecified prohibition items.
	● Prohibition against disassembly Notification of disassembly of products, when doing so can cause possible electric shock.
	● General warning Notification of general, unspecified actions that users must perform.
	● Warning against rupture Notification of possible rupture under certain conditions.

## ● Precautionary Information

### CAUTION

Minor injury by electrocution may occasionally occur. Do not touch any of the terminals while power is being supplied. Be sure to mount the terminal cover after wiring. When mounting a surface-mounting model on exposure, always install the Y92A-72H terminal cover (separately purchased).	
Minor injury due to explosion may occasionally occur. Do not use product where subject to flammable or explosive gas.	
Minor electric shock, fire or malfunction may occasionally occur. Never attempt to disassemble, modify, or repair the product or touch any of the internal parts.	
Fire may occasionally occur. Tighten the terminal screws to the rated torque (from 0.98 to 1.17N·m).	
Unexpected operation may occasionally occur. Before changing times or other settings while power is being supplied, either turn OFF the power on the load side or set the output ON/OFF switch to OFF and confirm the safety of the system.	
Minor electric shock, fire, or malfunction may occasionally occur. Do not allow metal fragments or lead wire scraps to fall inside the Time Switch.	
If the output relay is used beyond its life expectancy, its contacts may become fused or there may be a risk of fire. Use the output relay within its rated load and electrical life expectancy. The life expectancy of the output relay varies considerably according to its usage.	
Serious injury may occasionally occur due to fire or explosion of a battery, or leakage from a battery. Never attempt to short the positive and negative terminals, recharge, disassemble, deform by applying excessive pressure, or expose the battery to fire.	

# Precautions for Safe Use

Please comply strictly with the following instructions which are intended to ensure safe operation of the controller.

- (1) Install the Time Switch only by qualified electrical workers.
- (2) Store the Time Switch within the specified ratings. If the Time Switch has been stored at temperatures  $-10^{\circ}\text{C}$  or lower, let it stand for 3 hours or longer at room temperature before turning ON the power supply.
- (3) Mounting the Time Switch side-by-side may reduce the life expectancies of internal components.
- (4) Use the Time Switch within the specified ratings for operating temperature and humidity.
- (5) Do not operate the Time Switch in any of the following locations.
  - Locations subject to sudden or extreme changes in temperature.
  - Locations where high humidity may result in condensation.
- (6) The Time Switch is not waterproof or oil resistant. Do not use it in locations subject to water or oil.
- (7) Do not use the Time Switch in locations subject to excessive dust, corrosive gas, or direct sunlight.
- (8) Install the Time Switch well away from any sources of excessive static electricity, such as pipes transporting molding materials, powders, or liquids.
- (9) Maintain voltage fluctuations in the power supply within the specified range.
- (10) Internal elements may be destroyed if a voltage outside the rated voltage is applied.
- (11) Be sure to wire the terminals correctly.
- (12) Separate the Time Switch, the devices that generate input signals, input signal wires from any potential sources of noise, such as high-voltage lines.
- (13) Do not connect more than two crimp terminals to each Time Switch terminal.
- (14) Up to two wires of the same size and type can be inserted into a single terminals.
- (15) Use the specified wires for wiring.
  - Applicable wire: AWG 22 to AWG 14 (equal to a cross-sectional area of  $0.326$  to  $2.081\text{ mm}^2$ )
  - Solid wire or twisted wire
  - Copper
- (16) Install a switch or circuit breaker that allows the operator to immediately turn OFF the power, and label it to clearly indicates its function.

- (17) Take adequate protective measures (such as a breaker, or fuse) for the power supply of the Time Switch.
- (18) When using heaters, be sure to use a thermal switch for the load circuit.
- (19) Always maintain the load current within specifications.
- (20) Use a switch, relay, or other contacts so that the rated power supply voltage will be reached within 0.1 s. If the power supply voltage is not reached quickly enough, the Time Switch may malfunction or outputs may be unstable.
- (21) Use a switch, relay, or other contact to turn the power supply OFF instantaneously. Outputs may malfunction and memory errors may occur if the power supply voltage is decreased gradually.
- (22) The Time Switch utilizes a transformerless power supply. Do not touch the input terminal while power is being supplied; touching live terminals may result in electric shock.
- (23) Use the Time Switch within the specified ratings for vibrations or shock.
- (24) Use a commercial power supply when using AC input type as a power supply voltage input.  
Although some inverters specify their output frequency to 50/60 Hz as output specification, smoke or burnout may occur from a rise in internal temperature. Do not use inverter output as the power supply.
- (25) Do not leave the Time Switch for long periods at a high temperature with output current in the ON state. Doing so may result in the premature deterioration of internal components (e.g., electrolytic capacitors).
- (26) Do not use organic solvents (such as paint thinner or benzene), strong alkaline, or strong acids because they will damage the external finish.
- (27) None of the Time Switch components are user-replaceable, including the battery.
- (28) Use a tool such as long nose pliers to form a gate to pull wires out of the optional large terminal cover, Y92A-72H. Processing by hand may result in injury due to gate vestige.

## Precautions for Correct Use

- (1) When the power is turned ON, an inrush current will flow for a short time (AC: Approx. 2.5 A (0.3ms), DC: Approx. 1.1 A (3ms)). Depending on the power supply capacity, operation may not start. Be sure to use a power supply with a sufficient capacity and a breaker.
- (2) Inrush current generated by turning ON or OFF the power supply may deteriorate contacts on the power supply circuit. Turn ON or OFF to a device with the rated current of more than 10A.
- (3) Batteries are used to back up the clock function and setup program. If the battery life is about to end, it causes abnormal display or operation. Batteries cannot be replaced by customers. Please contact our dealers.



Contains Batteries  
Don't Put in Trash  
Recycle or Dispose as Hazardous  
Waste.

# Table of Contents

Suitability for Use	1
Safety Precautions	1
Precautionary Information	2
Precautions for Safe Use	3.4
Precautions for Correct Use	4
Table of Contents	5.6
★How would you like to use the Time Switch?	7.8

## Operation

1. Operating Functions	9
2. Nomenclature	10.11.12
3. Time Adjustment	13.14
4. Basic Operations	
4-1. Ordinary Timer Operation	15.16
4-2. Multiple-day Operation	17.18
4-3. Pulse-output Operation	19.20
4-4. Cyclic Operation	21.22
4-5. Programming for the 4 channel type	23
4-6. About Yearly Program	23
4-7. Yearly Timer Operation	24.25.26
4-8. Yearly Pulse-output Operation	27.28
4-9. Clearing the Settings	29.30
5. Convenient Functions	
5-1. Setting (Temporary) Holidays	31~34
5-2. Program Check Function	35
5-3. Checking the Settings	36
5-4. Day Override Operation	37.38
5-5. Summer Time (DST) Adjustment (Manual)	39
5-6. Switching between 12-hour and 24-hour Display	39
5-7. Display Switching	40
5-8. Override and Automatic Return Operation	41.42

6. Advanced Operations	
6-1. Total Time/Count Display	43
6-2. Time Adjustment Input Function	44
6-3. Manual Operation on Recovery from Power Failure	44
6-4. Bank Switching	45
6-5. Season Switching	46
6-6. Initial Setting Mode	47
6-6-1. F1: Next Operation Display	48
6-6-2. F2: Input Selection	49
6-6-3. F3: Total Time Alarm	50
6-6-4. F4: Total Count Alarm	51
6-6-5. F5: Date Format Selection	52
6-6-6. F6: Summer Time (DST) Adjustment	53
6-6-7. F7: Summer Time Schedule Selection	54
6-6-8. F8: Season Switching	55
6-6-9. F9: Period of Season	56
7. Operation while the Power Supply is OFF	57
8. Resetting	57
9. Time Accuracy	58
10. About Displayed Symbols	58
11. Troubleshooting	59

## Installation

1. Dimensions and Mounting Dimensions	60~62
2. Connections	63
3. Wirings	64.65
4. Ratings and Characteristics	66
5. Output (Built-in Relay) Life Expectancy	67
6. EN/IEC Standards	67
7. Accessories and Replacement Parts	68
8. Record of Settings	69.70

# ★ How would you like to use the Time Switch?

The H5S Time Switch offers **simple operation** to set various time controls.

You want the Time Switch to turn an output ON/OFF at a scheduled time.

- <Cases>
- You want to put a machine into operation between certain times.
  - You want to turn on a light between certain times.

Timer operation is recommended.

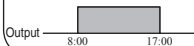

4-1

You want the Time Switch to turn outputs ON/OFF over several days.

- <Cases>
- You want to put a machine into operation from 22:00 to 8:00 in the next morning.
  - You want to turn ON an output at 10:00 on Monday and turn it OFF at 17:00 on Friday.

Multiple-day operation is recommended.

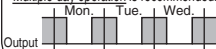

4-2

You need a pulse-output for a short time.

- <Cases>
- You need an ON pulse-output to activate a device for preheating.
  - You want to ring a chime or time signal.

Pulse-output operation is recommended.

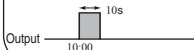

4-3

You want the Time Switch to turn outputs ON/OFF at the same intervals.

- <Case>
- You want to water plants for five minutes every hour from 9:00 to 17:00.

Cyclic operation is recommended.

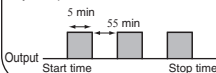

4-4

You want the Time Switch to automatically switch programs according to season.

The season switching function is useful to switch programs between summer and winter or other seasons. (Yearly types only)  
The bank switching function can also switch programs manually. (Weekly type only)



6-4,6-5

You want to set an extra program on a specified date.

- <Case> Although Sunday is set as a non-operating day in weekly operation, you want the Time Switch to perform a certain operation.

Yearly operation can be added.

4-6

※ Refer to the main part to know the other functions or those details.



## The H5S Time Switch has other convenient functions.

You want the Time Switch to turn OFF outputs on national holidays or unscheduled holidays.

The scheduled outputs are turned OFF temporarily, for example, only on the next Wednesday or during summer holidays from August 13 to August 15 by using holiday setting function.

Weekly type : Day specified  
Yearly type : Date specified



You want to monitor the periods for or the times at which load is turned ON.

The H5S Time Switch features total time/count display with alarm (except for 4 channel type). This feature is useful to ensure long load life including lamps and motors.



You want to check the set one-week programs in a simple manner.

The set ON/OFF times for one week can be displayed in the sequence the Time Switch is to operate by program check function.

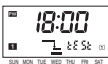

You want to check the programs set for Wednesday in a simple manner.

Checking mode is useful to check the programs set for a particular day.

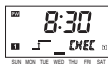

When several Time Switches are installed, the time is fast or slow.







The time can be adjusted by applying an external input (except for 4 channel type). When group-mounting two or more Time Switches, their times can be synchronized.



You want to use the Time Switch in summer time (DST) zone.

You can change the time to summer time (1 hour ahead) simply by pressing a Key. Automatic summer time adjustment is possible for yearly type.



- Switching between 12-hour (am/pm) and 24-hour Display  Refer to Section 5-6
- Display switching  Refer to Section 5-7
- Override and automatic return operation  Refer to Section 5-8
- Day override operation  Refer to Section 5-4
- Next operation display  Refer to Section 6-6-1
- Date format selection  Refer to Section 6-6-5
- Manual operation on recovery from power failure  Refer to Section 6-3

※ Refer to the main part to know the other functions or those details.

# Operation

## 1. Operating Functions Weekly 2 chnls Yearly 2 chnls Yearly 4 chnls

The H5S, Digital Time Switch, has mainly three types. The main functions of these types are as shown in the following table. Operating functions are different depending on models. Please check the model and number, and read this manual thoroughly.

		Pages	Weekly 2 chnls	Yearly 2 chnls	Yearly 4 chnls
			H5S-WB2(D) H5S-WFB2(D)	H5S-YB2(D)-X H5S-YFB2(D)-X	H5S-YB4(D)-X H5S-YFB4(D)-X
Weekly operation	Timer operation	4-1,4-2	○	○	
	Pulse-output operation	4-3	○	○	
	Cyclic operation	4-4	○	○	
Yearly operation	Timer operation	4-7	×	○ (※)	
	Pulse-output operation	4-8	×	○ (※)	
Setting holidays		5-1	○(Specifying a day)	○(Specifying a date)	
Day override operation		5-4	○(Specifying a day)	×	
Program check function		5-2		○	
Checking the setting		5-3		○	
Override and automatic return operation		5-8		○	
Summer time (DST) adjustment		5-5,6-6	○(Manual only)	○(Manual / automatic)	
Operation on recovery from power failure		6-3	Automatic / Manual selectable		Automatic only
Time adjustment input function		6-2		○	×
Total time/count display		6-1		○	×
Bank switching		6-4	○	×	
Season switching		6-5	×	○	
Operation during power OFF		7		○	

※ Yearly programs are added to weekly programs.  
Refer to "Section 4-6 About yearly programs".

# 2. Nomenclature

Weekly  
2 chnls

## <Front panel>

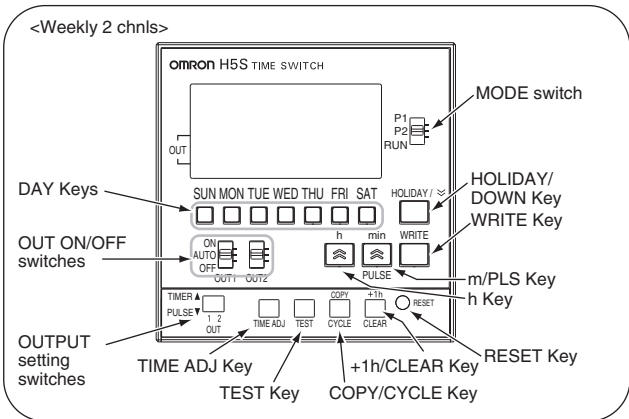

## <Display>

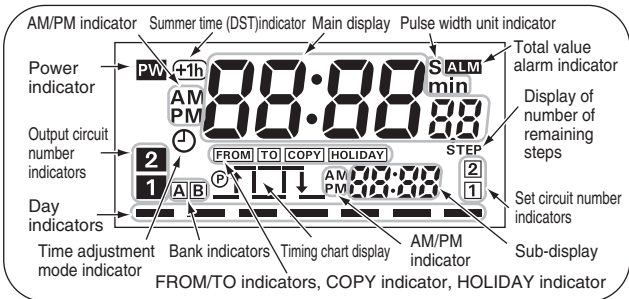

# 2. Nomenclature

Yearly  
2 chnls

## <Front panel>

<Yearly 2 chnls>

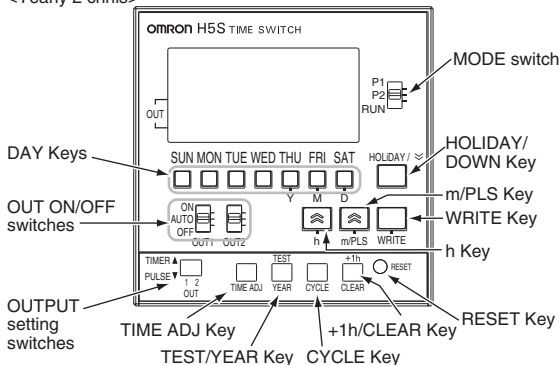

## <Display>

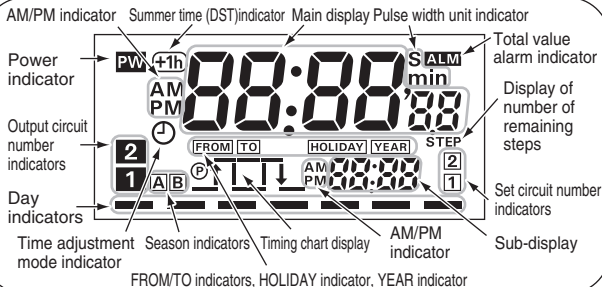

# 2. Nomenclature

Yearly  
4 chnls

## <Front panel>

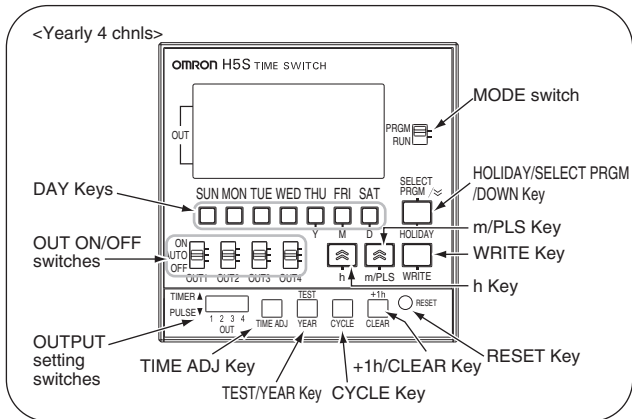

## <Display>

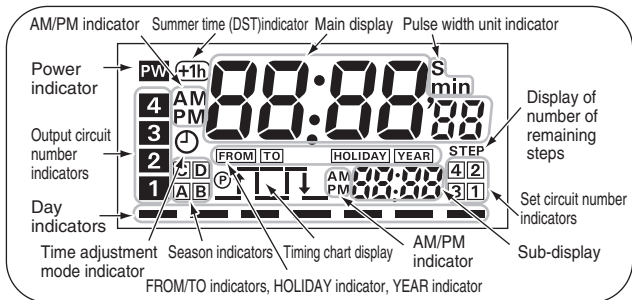

# 3. Time Adjustment

Weekly  
2 chnls

**【Example】** The current time (day/hour/minute) is set to Saturday 17:28.

- ① Set the Mode Switch to RUN.



- ② Press **TIME ADJ** for 2 s or more.  
The  symbol flashes.

The  color indicates flashing.



- ③ Press **SAT**.  
(The bar (  ) mark at the Saturday position will turn ON.)  
Set the time with **h** and **m**. ※1

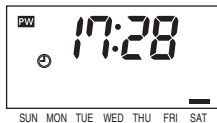

- ④ Press **WRITE** to confirm the setting, and the Time Switch will start timing from 0 second.

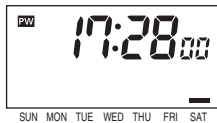

- ※1 Holding down these Keys rapidly advances the value.  
Pressing  decrements the value of the Key that was last pressed.

## 《Note》

- On first power-up or after a reset (  Section 8), the time adjustment display appears on the screen. Adjust the time by following the steps ③ and ④.
- If **TIME ADJ** is pressed again before confirming the time adjustment setting, the setting is cancelled.

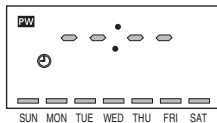

# 3. Time Adjustment

Yearly  
2 chnls

Yearly  
4 chnls

**【Example】** The current time is set to 17:28 on August 15, 2006.

- ① Set the Mode Switch to RUN.



2 chnls



4 chnls

The  color indicates flashing.

- ② Press **TIME ADJ** for 2 s or more.  
The  symbol flashes.



- ③ Specify the date by pressing **Y**, **M** and **D**. \*1



- ④ Press **WRITE**.  
Set the time with **h** and **m**. \*1



- ⑤ Press **WRITE** to confirm the settings,  
and the Time Switch will start timing from 0 second.

- \*1 Holding down these Keys rapidly advances the value.  
Pressing  decrements the value of the Key that was last pressed.



## «Note»

- On first power-up or after a reset (➔ Section 8), the time adjustment display appears on the screen. Adjust the time by following the steps ③ through ⑤.
- If **TIME ADJ** is pressed again before confirming the time adjustment setting, the setting is cancelled.

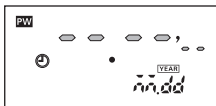

# 4. Basic Operations

## 4-1. Ordinary Timer Operation Weekly 2 chnls Yearly 2 chnls Yearly 4 chnls

**【Example】** The Time Switch turns ON circuit 1 or circuit 2 at 8:30 and turns it OFF at 17:15 from Monday through Friday.

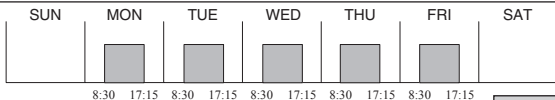

- ① Set the Mode Switch to P1 or P2. ※1  
→See Section 4-5 for 4 channel type.

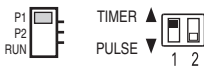

- ② Press the DAY Keys to turn on the bars (—) at the positions of Monday through Friday. Set the ON time with [h] and [m]. ※2

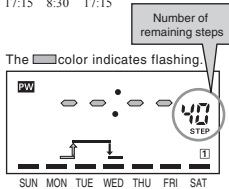

- ③ Press [WRITE]. Set the OFF time with [h] and [m]. ※2



- ④ Press [WRITE] to confirm the settings.

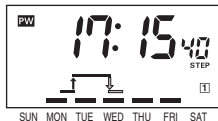

- ※1 If one or more programs have already been set, the display starts showing the set programs. To add another program, press [WRITE] repeatedly until "--:--" is displayed.  
※2 Holding down these Keys rapidly advances the value. Pressing [ ] decrements the value of the Key that was last pressed.



«Note»

- If multiple settings are required, repeat the steps ② through ④.
- Both the ON and OFF times must be set.
- All the set weekly programs can be checked by pressing **WRITE** in program setting mode.
- When the Mode Switch is set to P1 or P2 (to PRGM for 4 channel type), the Time Switch stop automatic operation. To forcibly turn ON or OFF the output, use the OUT ON/OFF switches.
- The set data will be cleared if the OUTPUT setting switch is moved between the TIMER and PULSE positions after the data has been set.

# 4-2. Multiple-day operation

Weekly  
2 chnls

Yearly  
2 chnls

Yearly  
4 chnls

**[Example1]** The Time Switch turns circuit 1 or circuit 2 ON continuously between 8:30 on Monday and 17:15 on Friday.

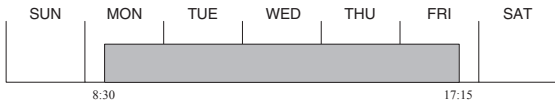

- ① Set the Mode Switch to P1 or P2. ※1  
→See Section 4-5 for 4 channel type.

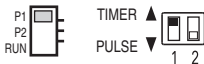

- ② Press **[MON]** to turn on the bar (—) at the Monday position.  
Set the ON time with **[h]** and **[m]**. ※2

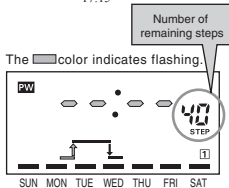

- ③ Press **[WRITE]**.  
**Press [MON] to turn off the bar (—) at the Monday position and press [FRI] to turn on the bar (—) at the Friday position.**  
Set the OFF time with **[h]** and **[m]**. ※2

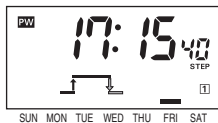

- ④ Press **[WRITE]** to confirm the settings.

- ※1 If one or more programs have already been set, the display starts showing the set programs. To add another program, press **[WRITE]** repeatedly until "--:--" is displayed.  
※2 Holding down these Keys rapidly advances the value. Pressing **[↵]** decrements the value of the Key that was last pressed.

**[Example 2]** The Time Switch turns ON circuit 1 or circuit 2 at 22:00 from Monday through Friday and turns it OFF at 8:00 each following morning.

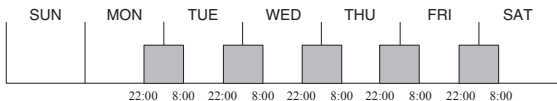

- ① Set the Mode Switch to P1 or P2. ※1  
→See Section 4-5 for 4 channel type.

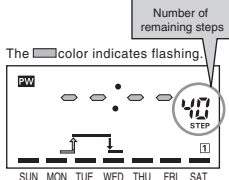
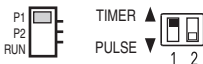

- ② Press the DAY Keys to turn on the bars (—) at the positions of Monday through Friday. Set the ON time with [h] and [m]. ※2



- ③ Press [WRITE].  
Press [MON] to turn off the bar (—) at the Monday position and press [SAT] to turn on the bar (—) at the Saturday position.

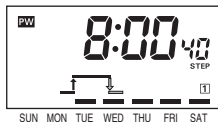

Set the OFF time with [h] and [m]. ※2

- ④ Press [WRITE] to confirm the settings.

- ※1 If one or more programs have already been set, the display starts showing the set programs. To add another program, press [WRITE] repeatedly until "--:--" is displayed.  
※2 Holding down these Keys rapidly advances the value. Pressing [≡] decrements the value of the Key that was last pressed.

# 4-3. Pulse-output Operation

Weekly  
2 chnls

Yearly  
2 chnls

Yearly  
4 chnls

**[Example]** The Time Switch turns ON circuit 1 or circuit 2 for 30 seconds at 8:25 am from Monday through Saturday.

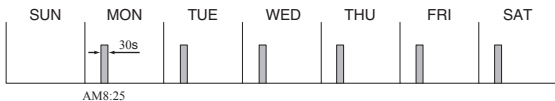

- ① Set the Mode Switch to P1 or P2. ※1  
→See Section 4-5 for 4 channel type.

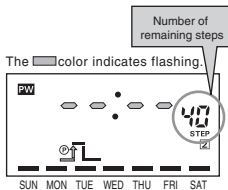

- ② Press the DAY Keys to turn on the bars (—) at the positions of Monday through Saturday. Set the ON time with [h] and [m]. ※2



- ③ Press [WRITE].  
Set the pulse width with [PLS]. ※2  
The displayed pulse width changes by pressing this Key in the following order.  
1s→2s→...→59s→1m→...59m→60m→1s

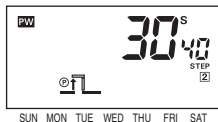

- ④ Press [WRITE] to confirm the settings.

- ※1 If one or more programs have already been set, the display starts showing the set programs. To add another program, press [WRITE] repeatedly until "--:--" is displayed.
- ※2 Holding down these Keys rapidly advances the value. Pressing [▽] decrements the value of the Key that was last pressed.

«Note»

- If multiple settings are required, repeat the steps ② through ④.
- Both the ON time and pulse width must be set.
- All the set weekly programs can be checked by pressing **WRITE** in program setting mode.
- When the Mode Switch is set to P1 or P2 (to PRGM for 4 channel type), the Time Switch stops automatic operation. To forcibly turn ON or OFF the output, use the OUT ON/OFF switches.
- The set data will be cleared if the OUTPUT setting switch is moved between the TIMER and PULSE positions after the data has been set.

# 4-4. Cyclic Operation

Weekly  
2 chnls

Yearly  
2 chnls

Yearly  
4 chnls

**[Example]** The Time Switch turns circuit 1 or circuit 2 ON for 5 minutes and OFF for 1 hour 55 minutes repeatedly from 8:00 to 19:00 on Sunday.

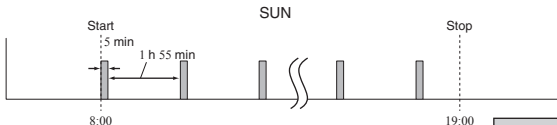

- ① Set the Mode Switch to P1 or P2. ※1  
→See Section 4-5 for 4 channel type.

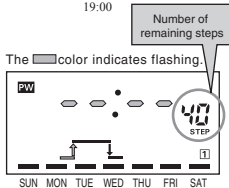

- ② Press **[CYCLE]**.  
(The display moves to cyclic program setting mode.)

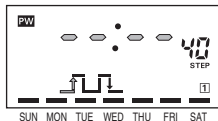

- ③ Press **[SUN]** to turn on the bar (—) at the Sunday position.  
Set the start time to 8:00 with **[h]** and **[m]**. ※2

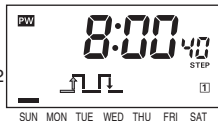

- ④ Press **[WRITE]**.  
Set the stop time to 19:00 with **[h]** and **[m]**. ※2

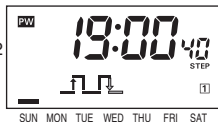

- ⑤ Press **WRITE** .  
Set the ON time period with **h** and **m**. ※2

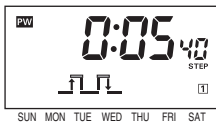

- ⑥ Press **WRITE** .  
Set the OFF time period with **h** and **m**. ※2

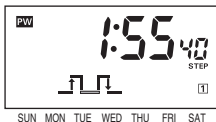

- ⑦ Press **WRITE** to confirm the settings.

- ※1 If one or more programs have already been set, the display starts showing the set programs.  
To add another program, press **WRITE** repeatedly until "-:-:-" is displayed.
- ※2 Holding down these Keys rapidly advances the value.  
Pressing **⇩** decrements the value of the Key that was last pressed.

«Note»

- If multiple settings are required, repeat the steps ② through ⑦.
- All the start/stop times, ON/OFF time periods must be set.
- All the set weekly programs can be checked by pressing **WRITE** in program setting mode.
- When the Mode Switch is set to P1 or P2 (to PRGM for 4 channel type), the Time Switch stops automatic operation. To forcibly turn ON or OFF the output, use the OUT ON/OFF switches.
- Set Cyclic operation so as not to overlap other operations in individual circuits.
- The set data will be cleared if the OUTPUT setting switch is moved between the TIMER and PULSE positions after the data has been set.

## 4-5. Programming for 4 channel type

Yearly  
4 chnls

The following shows how to program (select an output) for 4 channel type.

- ① Set the Mode Switch to PRGM.



- ② Select an output with **SELECT PRGM**.

Pressing the Key changes the set circuit number displayed in lower right corner of the LCD.

→1→2→3→4→1→

The rest of the procedure is the same as for 2 channel types.

The color indicates flashing.

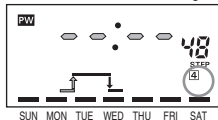

- ※The circuit number cannot be changed during the course of setting.

## 4-6. About Yearly Program

Yearly  
2 chnls

Yearly  
4 chnls

Yearly programs in addition to ordinary weekly programs can be set for 2 and 4 channel yearly types.

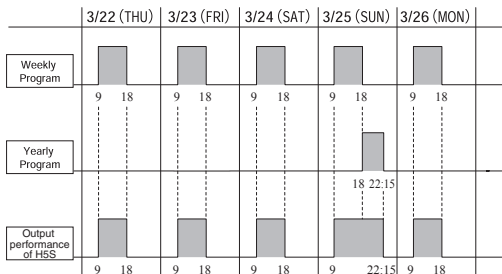

- ※If a weekly program and a yearly program overlap in operation time, the output of the H5S is continuously produced without being interrupted.



# 4-7. Yearly Timer Operation

Yearly  
2 chnls

Yearly  
4 chnls

**【Example 1】** The Time Switch turns ON a circuit at 18:00 and turns it OFF at 22:15 on March 25 every year.

Set the program in the following order.

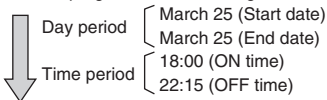

- ① Set the Mode Switch to P1 or P2. ※1  
→See Section 4-5 for 4 channel type.

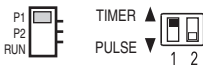

- ② Press **YEAR** for 1s or more.  
(The display moves to yearly program setting mode.)

The  color indicates flashing.

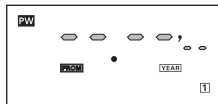
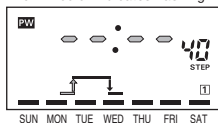

- ③ Specify the start date using **Y**, **M** and **D**. ※2  
Year can be set from the current year to the next two years as shown in the following example. If the year is set to "--", the operation performs every year.



<Example>If the current year is 2006,  
the displayed year changes as follows.  
--⇒06⇒07⇒08⇒--⇒06⇒

- ④ Press **WRITE**.  
Specify the end date using **Y**, **M**  
and **D**. ※2  
If the starting year has been set to "--",  
the ending year cannot be set.



- ⑤ Press **WRITE**.  
Set the ON time with **h** and **m**. ※2



- ⑥ Press **WRITE**.  
Set the OFF time with **h** and **m**. ※2

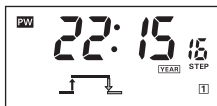

- ⑦ Press **WRITE** to confirm the settings.

- ※1 If one or more programs have already been set, the display starts showing the set programs.  
To add another program, press **WRITE** repeatedly until "--.--" is displayed.
- ※2 Holding down these Keys rapidly advances the value.  
Pressing **▽** decrements the value of the Key that was last pressed.

«Note»

- If multiple settings are required, repeat the steps ③ through ⑦.
- Yearly programs are added to weekly programs. (☞ Section 4-6)
- All the start/end dates and ON/OFF times must be set. The maximum number of yearly timer operations that can be set is 4 for each output channel.
- It is possible to set the Time Switch to operate for only one day (i.e., the start date is the same date as the end date).
- If one or more yearly programs have been set, the "**YEAR**" indicator light will turn on in run mode whether the yearly program is performed or not.
- When the year is specified, do not set the start date and end date in reverse sequence.
- The set data will be cleared if the OUTPUT setting switch is moved between the **TIMER** and **PULSE** positions after the data has been set.

**【Example 2】** The Time Switch turns a circuit ON continuously between 18:00 on March 25, 2006 and 12:00 on April 9, 2006.

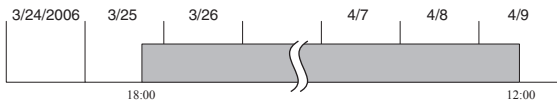

To set multiple-day operation in yearly program setting mode, two yearly programs are required to be set as shown in the following example.

Program①

March 25, 2006 (Start date)  
 April 8, 2006 (End date)  
 18:00 (ON time)  
 12:00 (OFF time)

+

Program②

March 26, 2006 (Start date)  
 April 8, 2006 (End date)  
 8:00 (ON time)  
 22:00 (OFF time)

※Output performance when no weekly programs are set on March 25 and April 9.

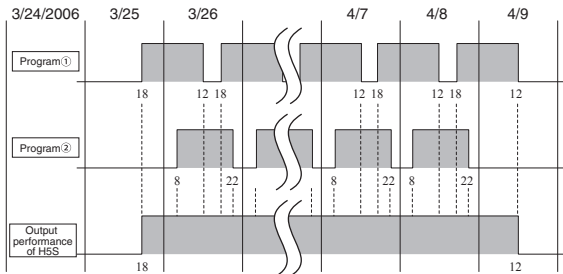

# 4-8. Yearly Pulse-output Operation

Yearly  
2 chnls

Yearly  
4 chnls

**[Example]** The Time Switch turns ON a circuit to operate for 2 minutes at 18:00 between March 25 and April 9.

Set the program in the following order.

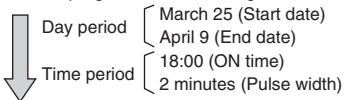

- ① Set the Mode Switch to P1 or P2. ※1  
→See Section 4-5 for 4 channel type.

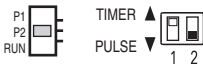

The  color indicates flashing.

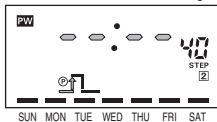

- ② Press **YEAR** for 1 s or more.  
(The display moves to yearly program setting mode.)

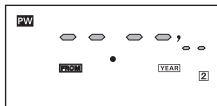

- ③ Specify the start date using **Y**, **M** and **D**. ※2  
Year can be set from the current year to the next two years as shown in the following example. If the year is set to "--", the operation performs every year.



<Example> If the current year is 2006,  
the displayed year changes as follows.

--⇒06⇒07⇒08⇒--⇒06⇒

- ④ Press **WRITE** .  
Specify the end date using **Y**, **M**  
and **D** .※2  
If the starting year has been set to "- -",  
the ending year cannot be set.



- ⑤ Press **WRITE** .  
Set the ON time with **h** and **m** .※2



- ⑥ Press **WRITE** .  
Set the pulse width with **PLS** .  
The displayed pulse width changes by  
pressing this Key in the following order.  
1s→2s→...→59s→1m→...→59m→60m→1s

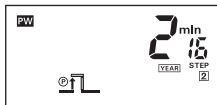

- ⑦ Press **WRITE** to confirm the settings.

- ※1 If one or more programs have already been set, the display starts showing the set programs.  
To add another program, press **WRITE** repeatedly until "- - - -" is displayed.
- ※2 Holding down these Keys rapidly advances the value.  
Pressing **▽** decrements the value of the Key that was last pressed.

《《Note》》

- If multiple settings are required, repeat the steps ③ through ⑦.
- Yearly programs are added to weekly programs. (☞ Section 4-6)
- All the start/end dates, ON time, and pulse width must be set. The maximum number of yearly pulse-output operations that can be set is 4 for each output channel.
- It is possible to set the Time Switch to operate for only one day (i.e., the start date is the same date as the end date).
- If one or more yearly programs have been set, the "YEAR" indicator light will turn on in run mode whether the yearly program is performed or not.
- When the year is specified, do not set the start date and end date in reverse sequence.
- The set data will be cleared if the OUTPUT setting switch is moved between the TIMER and PULSE positions after the data has been set.

# 4-9. Clearing the Settings

Weekly  
2 chnls

Yearly  
2 chnls

Yearly  
4 chnls

## 【Example 1】 Clearing a part of the settings.

- ① Set the Mode Switch to P1 or P2 and select a setting to be cleared.

See Section 4-5 for 4 channel type.

The  color indicates flashing.



- ② Give a short press on **CLEAR**.  
("EL" appears on the main display and "STEP" on the sub-display.)

※ If **CLEAR** is held down for 3 s or more, the display moves to the mode for clearing all the settings of the circuit.

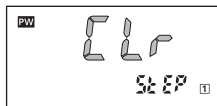

- ③ Press **WRITE** to clear the setting.

### «Note»

- If **CLEAR** is pressed while "EL" is flashing, clearing operation is cancelled.
- Each operation clears the following combination of settings.

Timer operation (weekly)	Both the ON/OFF times
Pulse-output operation (weekly)	Both the ON time and pulse width
Cyclic operation (weekly)	Both the start/stop times and ON/OFF time periods
Timer operation (yearly)	Both the start/end dates and ON/OFF times
Pulse-output operation (yearly)	Both the start/end dates, ON time and pulse width
Holiday operation (weekly)	All the holiday settings
Holiday operation (yearly)	Both the start/end dates
Day override operation (weekly)	All the day override operation settings

## 【Example 2】 Clearing **all the settings** of each circuit.

- ① Set the Mode Switch to the position of the circuit whose settings are to be cleared.  
See Section 4-5 for 4 channel type.

The  color indicates flashing.

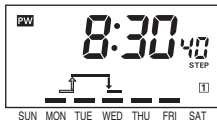

- ② Hold down **CLEAR** for 3 s or more.  
("EL" appears on the main display and "ALL" on the sub-display.)

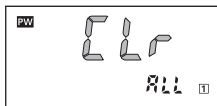

- ③ Press **WRITE** to clear all the settings of the circuit.

### «Note»

- If **CLEAR** is pressed while "EL" is flashing, clearing operation is cancelled.
- The current time, set data of initial setting mode, holiday settings, or day override settings cannot be cleared in the same manner.
- Yearly programs are also cleared with the yearly types.

# 5. Convenient Functions

## 5-1. Setting (Temporary) Holidays (Weekly) Weekly 2 chnls

Temporary holidays (non-operating days) can be set with ease. As the setting is automatically cleared after passing the days set as holidays, temporary holidays are easily set without changing the other settings including the output switches.

**【Example】** Friday and Saturday in the current week are set as holidays (non-operating days).  
The Time Switch operates according to the previous settings from the following week on.

- ① Press **HOLIDAY** for 2 s or more in run mode.  
(The display moves to holiday setting mode.)

The    color indicates flashing.

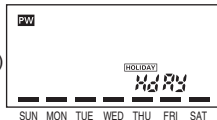

- ② Turn off the bars (—) at the positions of the days set as holidays.  
Bar ON: Operating day ⇔ Bar OFF: Holiday

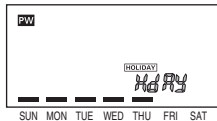

- ③ Press **WRITE** to confirm the setting.  
After "HdRY" is displayed for approximately 1 s, the display returns to RUN mode.



«Note»

- Any day in the 7-day period starting from the current day can be set as a holiday.  
The setting is automatically cleared after passing the days set as holidays.
- All ON operations are cancelled on the holiday.
- The set holidays are valid for all the output channels.
- Holiday setting mode can be entered from run mode only.
- If the current day setting is changed, all holiday settings are cleared.
- The display automatically returns to run mode if no Key input is entered within 30 seconds or if **HOLIDAY** is pressed for 2 s or more.

◆ A display in run mode

On a day set as a holiday, the "**HOLIDAY**" indicator is lit.



◆ Clearing holiday settings

- ① Give a short press on **CLEAR** in holiday setting mode.
  - ② Press **WRITE** to clear the holiday settings.
- ※ If **CLEAR** is pressed while "CLR" is flashing, clearing operation is cancelled.

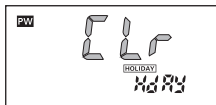

## 5-1. Setting (Temporary) Holidays (Yearly) Yearly 2 chnls Yearly 4 chnls

Temporary(\*) holidays (non-operating days) can be set simply by specifying dates.

As the setting is automatically cleared after passing the days set as holidays, temporary holidays are easily set without changing the other settings including the output switches.

※Annual holidays can be set.

**[Example]** The days between April 29 and May 7 in 2006 are set as holidays (non-operating days). The Time Switch operates according to the previous settings from the following year on.

- ① Press **HOLIDAY** for 2 s or more in run mode. ※1  
(The display moves to holiday setting mode.)

The  color indicates flashing.

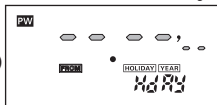

- ② Specify the start date of holidays using **Y**, **M** and **D**. ※2  
Year is displayed in the following order by pressing **Y**. (Year can be set from the current year to the next two years.)  
<Example> If the current year is 2006, the displayed year changes as follows.  
06⇒07⇒08⇒--⇒06⇒



If the year is set to --, the holiday setting is executed every year.

- ③ Press **WRITE**.  
In the same manner, specify the end date of holidays using **Y**, **M** and **D**. ※2  
If the starting year has been set to "--", the ending year cannot be set.



- ④ Press **WRITE** to confirm the settings.  
⑤ Press **HOLIDAY** for 2 s or more to return to run mode.

- ※1 If one or more programs have already been set, the display starts showing the set programs. To add another program, press **WRITE** repeatedly until "---" is displayed.  
※2 Holding down these Keys rapidly advances the value. Pressing  decrements the value of the Key that was last pressed.

«Note»

- Any date between the current date and December 31 in the year after the following year can be specified as a holiday.
- The setting is automatically cleared after passing the dates set as holidays (unless the year is set to --).
- If multiple settings are required, repeat the steps ② through ④.
- Both the start and end dates of holidays must be set. The maximum number of holidays that can be set is 16.
- Holiday setting mode can be entered from run mode only.
- If the current date setting is changed, all holiday settings will be cleared.
- When the year is specified, do not set the start date and end date in reverse sequence.
- If no Key input is entered within 30 s or if **HOLIDAY** is pressed again for 2 s or more, the display automatically returns to run mode.

◆ A display in run mode

On a day set as a holiday, the " **HOLIDAY** " indicator is lit.



◆ Clearing the holiday settings

<Clearing a part of holiday settings>

- ① When the holiday to be cleared is displayed, give a short press on **CLEAR**.
- ② Press **WRITE** to clear the holiday setting.

※ If **CLEAR** is pressed while "CLR" is flashing, clearing operation is cancelled.

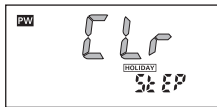

<Clearing all holiday settings>

- ① When any of the holiday settings is displayed, press **CLEAR** for 3 s or more.
- ② Press **WRITE** to clear all the holiday settings.

※ If **CLEAR** is pressed while "CLR" is flashing, clearing operation is cancelled.

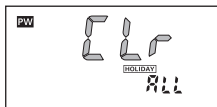

## 5-2. Program Check Function

Weekly  
2 chnls

Yearly  
2 chnls

Yearly  
4 chnls

The set days and times when output turns ON and OFF over the course of one week can be displayed in the sequence the Time Switch is to operate.

The   color indicates flashing.

- ① Press **TEST** for 2 s or more in run mode.  
("E E S t" flashes and the day and time of the next change in output state is displayed.)

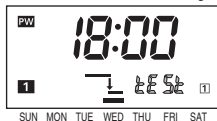

- ② Press **WRITE**.  
The display shows the time of the next change in output state.  
Each time **WRITE** is pressed, the display shows the days and times for one week.

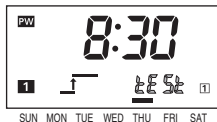

- ③ If **WRITE** is pressed while displaying the last setting for the week, "End" is displayed for 2 s and the Time Switch automatically returns to run mode.



### «Note»

- Output is not turned ON or OFF according to displays in program check mode but according to settings and the current time.
- Program check mode can be entered from run mode only.
- Holiday settings (☞ Section 5-1), day override operation settings (☞ Section 5-4: weekly type only), and yearly settings (☞ Section 4-6: yearly types only) are also displayed.
- Settings for one week from the current day on can be checked with this function.
- After one-week schedule set for the circuit 1 is displayed, the display starts to show one-week schedule set for the circuit 2.
- If no Key input is entered within 30 s or if **TEST** is pressed again for 2 s or more, the display automatically returns to run mode.

## 5-3. Checking the Settings

Weekly  
2 chnls

Yearly  
2 chnls

Yearly  
4 chnls

The set times for one day can be checked.

- ① Press one of the DAY keys for 2 s or more in run mode to check settings for the day. (“CHEE” flashes and the time of the next On time is displayed.)

The  color indicates flashing.

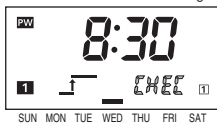

- ② Press **WRITE**.  
The display shows the time of the next change in output state.

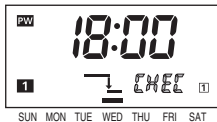

- ③ If **WRITE** is pressed with the last setting of the day displayed, “End” is displayed for 2 s before the Time Switch automatically returns to run mode.



### «Note»

- This mode can be entered from run mode only.
- Output is not turned ON or OFF according to displays but according to settings and the current time.
- Holiday settings (👉 Section 5-1), day override operation settings (👉 Section 5-4: weekly type only), and yearly settings (👉 Section 4-6: yearly types only) are also displayed.
- If no Key input is entered within 30 s or if one of the DAY keys is pressed again for 2 s or more, the display automatically returns to run mode.

## 5-4. Day Override Operation Weekly 2 chnls

Operation for one day can be temporarily (for only one week) executed on another day.

**【Example】** The operations set for Sunday is executed this Saturday.  
The Time Switch performs the ordinary operation (according to the previous settings) from next Saturday on.

- ① Press **COPY** for 2 s or more in run mode.  
(The display moves to day override operation setting mode.)

The  color indicates flashing.

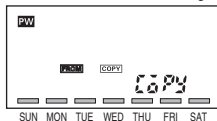

- ② Turn on the bar (■) at the position of the day which the operations set for are to be executed on another day.  
(The **COPY** indicator will flash.)

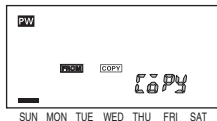

- ③ Press **WRITE** to select the day on which the operations are to be executed.

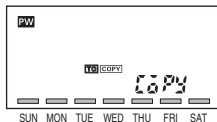

- ④ Turn on the bar (■) at the position of the day. More than one day can be selected.

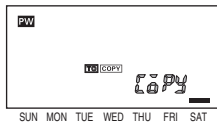

- ⑤ Press **WRITE** to confirm the setting.

«Note»

- Any day in the 7-day period starting from the current day can be set as a day on which another day's operations are to be executed. The setting is automatically cleared after passing the day.
- Day override operation setting mode can be entered from run mode only.
- The display returns to run mode if no Key input is entered within 30 seconds or if **COPY** is pressed for 2 s or more.

◆ Display in run mode

The **COPY** indicator is displayed on a day on which another day's operations are to be executed.

(It is Saturday in this example.)



◆ Clearing day override operation settings

- ① Give a short press on **CLEAR** in day override operation setting mode.
  - ② Press **WRITE** to clear the setting.
- ※ If **CLEAR** is pressed again, clearing operation is cancelled.

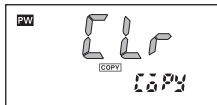

## 5-5. Summer Time (DST) Adjustment (Manual)

Weekly  
2 chnls

Yearly  
2 chnls

Yearly  
4 chnls

Each time **[+1h]** is pressed for 2 s or more, the current time switches between the current time and the current time+1 hour.

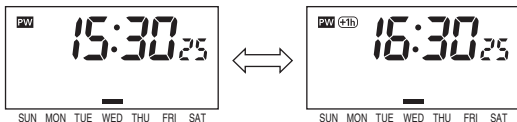

### «Note»

- The **[+1h]** indicator is turned on during summer time.
- Manual summer time adjustment is possible in run mode only.
- If summer time adjustment (☛ Section 6-6-6) is set to automatic for the yearly types, manual adjustment is disabled.
- The settings are not changed by summer time adjustment.

## 5-6. Switching between 12-hour and 24-hour display

Weekly  
2 chnls

Yearly  
2 chnls

Yearly  
4 chnls

Each time **[h]** is pressed for 2 s or more, the current time switches between 12-hour (am/pm) and 24-hour display.

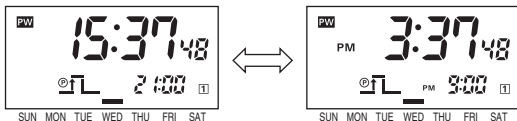

### «Note»

- Switching is possible only in run mode.
- The factory setting is 24-hour display.



## 5-7. Display Switching Weekly 2 chnls

Each time **[m]** is pressed for 2 s or more, the displayed content switches as shown below.

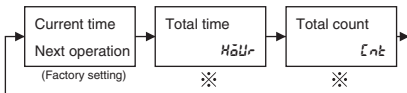

※Displays only when the input selection is set to “L 0 L L”. ( Section 6-6-2)

## 5-7. Display Switching Yearly 2 chnls

Each time **[m]** is pressed for 2 s or more, the displayed content switches as shown below.

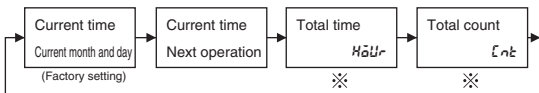

※Displays only when the input selection is set to “L 0 L L”. ( Section 6-6-2)

## 5-7. Display Switching Yearly 4 chnls

Each time **[m]** is pressed for 2 s or more, the displayed content switches as shown below.

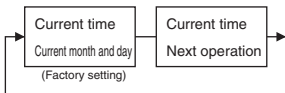

## 5-8. Override and Automatic Return Operation

Weekly  
2 chnls

Yearly  
2 chnls

Yearly  
4 chnls

This function forcibly turns ON/OFF an output without changing the state of automatic operations.

**[Example 1]** Regular setting: ON at 9:00; OFF at 17:00  
The Time Switch turns OFF an output at 15:00 today because of completing the production earlier than usual.

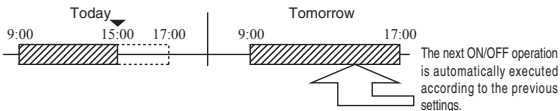

- ① Change the setting of the OUT ON/OFF switch from AUTO to OFF at 15:00.
- ② Turn the OUT ON/OFF switch from OFF to AUTO with **WRITE** pressed. (Output keeps in OFF state.)
- ③ The regular operation will be performed from the next ON time.



**[Example 2]** Regular setting: ON at 9:00; OFF at 17:00  
The Time Switch turns ON an output at 7:00 am today because of more production than usual.

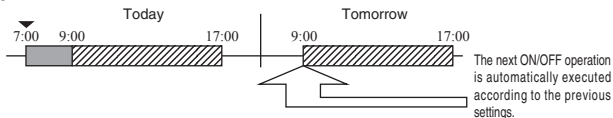

- ① Change the setting of the OUT ON/OFF switch from AUTO to ON at 7:00.
- ② Turn the OUT ON/OFF switch from ON to AUTO with **WRITE** pressed. (Output keeps in ON state.)
- ③ The regular operation will be performed from the next OFF time.



## 【Using override and automatic return operation for pulse-output operation】

Override and automatic return operation for pulse-output operation is as shown below.  
The operation procedure is the same as for timer operation.

**【Example 1】** The Time Switch executes an override and automatic return operation when output is OFF.

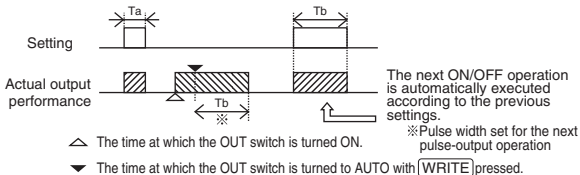

**【Example 2】** The Time Switch executes an override and automatic return operation when output is ON.

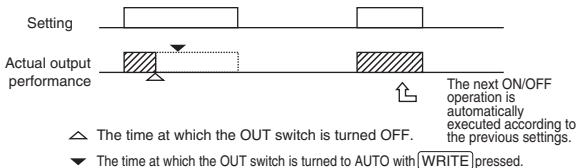

### 《《Note》》

- Override and automatic return operation is possible in run mode only (while the power is being supplied).
- To manually cancel the setting of override and automatic return operation, turn the OUT ON/OFF switch to the opposite position to the present output state.  
    <Example> Turning the OUT switch OFF when output is ON.
- If the power supply is turned OFF, the override and automatic return operation is cancelled.
- If the current time or the set programs are changed, the override and automatic return operation is cancelled.
- Do not execute override and automatic operation while cyclic operation is performed.

# 6. Advanced Operations

## 6-1. Total Time/Count Display Weekly 2 chnls Yearly 2 chnls

This function displays the total elapsed time and total count of external inputs.

If the upper limit of the total time or the total count is set, it is also possible to display the alarm indicator.

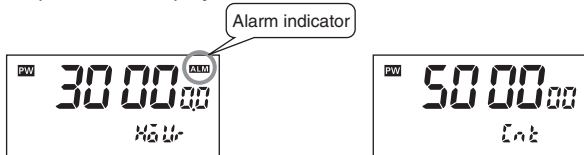

Total time display  
(Displayed when the total elapsed time is 30,000 hours.)

Total count display  
(Displayed when the total input count is 500,000.)

### <Resetting the total time and count>

- 1 Press **CLEAR** for 3 s or more while the total time or count is displayed.
- 2 Press **WRITE** to reset the total time and total count.

※The resetting is cancelled by pressing **CLEAR** again while "ELr" is flashing.

The  color indicates flashing.

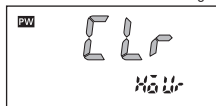

### «Note»

- Before using this function, input assignment is required. (➡ Section 6-6-2)
- How to display total time or count. (➡ Section 5-7)
- How to set the alarm value for the total time or count. (➡ Section 6-6-3, 6-6-4)
- The alarm indicator, **ALM**, will be displayed if either total time or count reaches its preset alarm value.
- The total time display is shown in 0.1 hour unit.
- When the total time/count exceeds 99999.9 h or 999999, the time/count returns to 0.
- The totalizing function cannot be used when power is OFF.
- Refer to "Section 3. Wiring" in the Installation for wiring.

## 6-2. Time Adjustment Input Function

**Weekly**  
2 chnls

**Yearly**  
2 chnls

Time can be set to 00 min 00 s at the same time as external input is applied. When group-mounting two or more Time Switches, their times can be synchronized.

### «Note»

- Before using this function, input assignment is required. (☞ Section 6-6-2)
- This function cannot be used when power is OFF.
- Refer to "Section 3. Wiring" in the Installation for wiring.

### Time synchronization possible!

Times of two or more H5S Time Switches can be synchronized.

<Configuration example>

The master unit is set to turn ON pulse-output on the hour (e.g. at noon) using output that is not used.

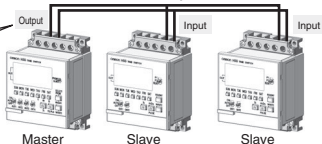

## 6-3. Manual Operation on Recovery from Power Failure

**Weekly**  
2 chnls

**Yearly**  
2 chnls

After power is restored to the H5S, it is possible to set the Time Switch to stop turning ON output until external input is applied.

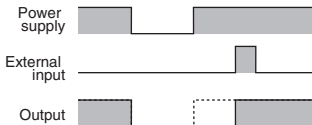

(In the upper left corner of the screen)

### «Note»

- This function is useful to prevent output from automatically turning ON after recovery from power failure.
- Before using this function, input assignment is required. (☞ Section 6-6-2)
- Refer to "Section 3. Wiring" in the Installation for wiring.

# 6-4. Bank Switching Weekly 2 chnls

Two groups (banks) of programs can be registered with the Time Switch. Banks can be switched by external input.

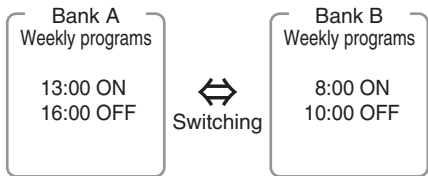

## ◆ Switching banks in run mode

Banks are switched as shown in the following table depending on external input state.

	Open-circuited	Short-circuited
Bank	A	B

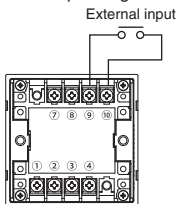

※ When a flush-mounting model is used

## ◆ Programming a bank

Press TIME ADJ in program setting mode to switch banks.

Different programs can be set for each bank.

### «Note»

- Before using this function, input assignment is required. (➡ Section 6-6-2)
- Refer to "Section 3. Wiring" in the Installation for wiring.

# 6-5. Season Switching

Yearly  
2 chnls

Yearly  
4 chnls

Weekly programs in response to seasons can be automatically switched throughout the year.

Mar. Apr. May Jun. Jul. Aug. Sept. Oct. Nov. Dec. Jan. Feb.

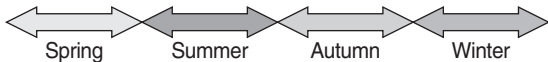

Seasons (※)	Spring	Summer	Autumn	Winter
Setting	17:30 ON 21:00 OFF	19:00 ON 22:00 OFF	18:00 ON 21:00 OFF	17:00 ON 21:00 OFF

※ Up to 4 seasons are set for the 4 channel type and up to 2 seasons are set for the 2 channel type.

## ◆ Switching seasons

A group of programs is automatically switched to another according to the seasons set in initial setting mode. (👉 Section 6-6-9)

## ◆ Programming a season

Press **TIME ADJ** in program setting mode to switch seasons.  
Different programs can be set for each season.

### 《Note》

- Before using this function, other settings are required in initial setting mode. (👉 Section 6-6-8, 6-6-9)
- This function switches weekly programs, but not yearly programs.

# 6-6. Initial Setting Mode

Weekly  
2 chnls

Yearly  
2 chnls

Yearly  
4 chnls

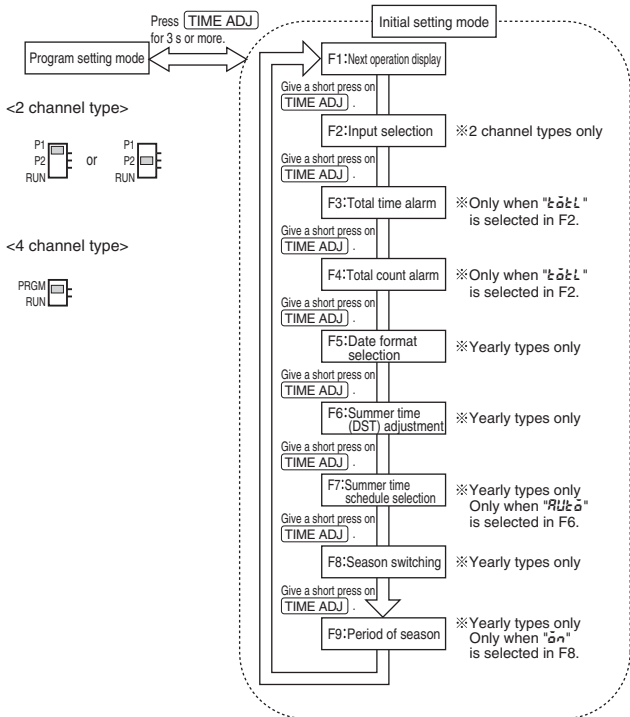

## 《Note》

- Initial setting mode can be entered from program setting mode only.
- Functions are different depending on the types and settings of the Time Switch.



# 6-6-1. F1: Next Operation Display

Weekly  
2 chnls

Yearly  
2 chnls

Yearly  
4 chnls

The output channels which the next operation (the next ON or OFF time) set for is displayed on the sub-display can be selected. This function is useful when operations in a particular channel is to be monitored.

## ◆ Parameters

- only 1** ... Displays a next operation in channel 1 only.
- only 2** ... Displays a next operation in channel 2 only.
- only 3** ... Displays a next operation in channel 3 only.
- only 4** ... Displays a next operation in channel 4 only.
- ALL 1234** ... Displays a next operation in all channels.

The display priority is 1 to 4.

(e.g.) If no program changing output

state are set for the circuit 1 within

24 hours, a set program for the circuit 2 is displayed.

※ Channel 3 and 4 are not displayed for 2 channel types.

※ **The inverted character** indicates the default.

The  color indicates flashing.



Displays a next operation in channel 1.

## ◆ Setting

The setting is made in F1 (next operation display) of initial setting mode.

- ① Press **TIME ADJ** for 3 s or more in program setting mode to enter initial setting mode.

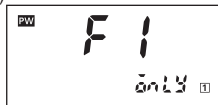

- ② Select one of the parameters using **h** or **m**. The symbol on the sub-display will flash.

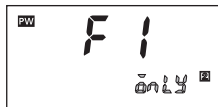

- ③ Press **WRITE** to confirm the setting. (The symbol of the sub-display will change from flashing to lighting.)

### 《Note》

- The programs changing output state within 24 hours are displayed as the next operations.
- Press **TIME ADJ** for 3 s or more to leave initial setting mode.
- If **TIME ADJ** is pressed again before confirming the setting, the setting is cancelled.
- How to display a next operation. (➡ Section 5-7)

# 6-6-2. F2: Input Selection

Weekly  
2 chnls

Yearly  
2 chnls

The functions of external input can be selected between input for setting manual operation after power failure recovery, totalizing input, time adjustment input, and bank switch input.

## ◆Parameters

- ... Input disabled
- bōōt** ... Input for setting manual operation after power failure recovery (➡ Section 6-3)
- tōtL** ... Totalizing input (➡ Section 6-1)
- SʒnL** ... Time adjustment input (➡ Section 6-2)
- bʀnʀ** ... Bank switch input (➡ Section 6-4)
  - ※ Bank switch input is available for the weekly 2 channel type only.
  - ※ **The inverted character** indicates the default.

## ◆Setting

The setting is made in F2 (input selection) of initial setting mode.

The   color indicates flashing.

- ① Press **TIME ADJ** for 3 s or more in program setting mode to enter initial setting mode. Give a short press on **TIME ADJ** and move to the F2 display.

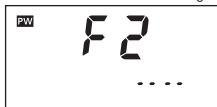

- ② Select one of the inputs using **h** or **m**. (The symbol on the sub-display will flash.)



- ③ Press **WRITE** to confirm the setting. (The symbol on the sub-display will change from flashing to lighting.)

### ◀Note▶

- To leave initial setting mode, press **TIME ADJ** for 3 s or more.
- If **TIME ADJ** is pressed again before confirming the setting, the setting is cancelled.
- If the input setting is changed from or to bank switch input, all the set programs will be cleared when **WRITE** is pressed.

## 6-6-3. F3: Total Time Alarm

Weekly  
2 chnls

Yearly  
2 chnls

The alarm value can be set for the total time. (👉 Section 6-1)

### ◆ Setting range

0.0 to 99990.0 h

※ Time is set in 10 hour unit.

※ The default is 0.0h (The alarm indicator output is off).

### ◆ Setting

The setting is made in F3 (total time alarm) of initial setting mode.

- ① Press **TIME ADJ** for 3 s or more in program setting mode to enter initial setting mode. Give short presses on **TIME ADJ** and move to the F3 display.

The    color indicates flashing.



- ② Alarm value setting display appears automatically in 2 s after entering F3. Press **h** or **m** to set an alarm value. (Pressing **≡** decrements the value of the Key that was last pressed.)

**h** : increments in 1,000 hour unit.

**m** : increments in 10 hour unit.



- ③ Press **WRITE** to confirm the setting. (After a one second pause, the screen returns to the initial display of F3.)

### «Note»

- F3 is displayed only when " ㊦㊦ " is selected in F2 (input selection).
- Alarm (**ALM** indicator) will be displayed when either the total time (F3) or the total count (F4) reaches the set alarm value.
- If an alarm value for the total time is set to 0, the alarm indicator does not appear.
- To leave initial setting mode, press **TIME ADJ** for 3 s or more.
- If **TIME ADJ** is pressed again before confirming the setting, the setting is cancelled.

## 6-6-4. F4: Total Count Alarm

Weekly  
2 chnls

Yearly  
2 chnls

The alarm value can be set for the total count. (☞ Section 6-1)

### ◆ Setting range

0 to 999900 (6 digits)

※ Count is set in the hundreds.

※ The default is 0 (The alarm indicator output is off).

### ◆ Setting

The setting is made in F4 (total count alarm) of initial setting mode.

- ① Press **TIME ADJ** for 3 s or more in program setting mode to enter initial setting mode. Give short presses on **TIME ADJ** and move to the F4 display.

The    color indicates flashing.

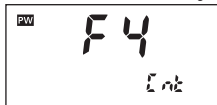

- ② Alarm value setting display appears automatically in 2 s after entering F4. Press **h** or **m** to set an alarm value. (Pressing **≡** decrements the value of the Key that was last pressed.)
- h** : increments in the ten thousands.  
**m** : increments in the hundreds.



- ③ Press **WRITE** to confirm the setting.  
(After a one second pause, the screen returns to the initial display of F4.)

### «Note»

- F4 is displayed only when " ㄱ ㄴ ㄷ " is selected in F2 (input selection).
- Alarm (**ALM** indicator) will be displayed when either total time (F3) or total count (F4) reaches the set alarm value.
- If an alarm value for the total count is set to 0, the alarm indicator does not appear.
- To leave initial setting mode, press **TIME ADJ** for 3 s or more.
- If **TIME ADJ** is pressed again before confirming the setting, the setting is cancelled.

# 6-6-5. F5: Date Format Selection

Yearly  
2 chnls

Yearly  
4 chnls

The displayed date format is selectable between "month. day" and "day. month".

## ◆Parameters

$\overline{m}\overline{m}.\overline{d}\overline{d}$  : "month. day"

$\overline{d}\overline{d}.\overline{m}\overline{m}$  : "day. month"

※ **The inverted character** indicates the default.

## ◆Setting

The setting is made in F5 (date format selection) of initial setting mode.

- ① Press **TIME ADJ** for 3 s or more in program setting mode to enter initial setting mode. Give short presses on **TIME ADJ** and move to the F5 display.

The   color indicates flashing.



- ② Change the setting using **h** or **m**. (The symbol on the sub-display will flash.)



- ③ Press **WRITE** to confirm the setting. (The symbol on the sub-display will change from flashing to lighting.)

### ◀◀Note▶▶

- The date format set in this function corresponds to all the displays showing a month and a day such as for "time adjustment", "setting programs" and "setting holidays".
- To leave initial setting mode, press **TIME ADJ** for 3 s or more.
- If **TIME ADJ** is pressed again before confirming the setting, the setting is cancelled.

## 6-6-6. F6: Summer Time (DST) Adjustment

Yearly  
2 chnls

Yearly  
4 chnls

Manual and automatic summer time adjustment is selectable.

### ◆Parameters

**OFF** : Manual adjustment

**Auto** : Automatic adjustment (Select summer time schedule in F7.)

※ **The inverted character** indicates the default.

### ◆Setting

The setting is made in F6 (summer time adjustment) of initial setting mode.

- ① Press **TIME ADJ** for 3 s or more in program setting mode to enter initial setting mode. Give short presses on **TIME ADJ** and move to the F6 display.

The   color indicates flashing.

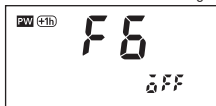

- ② Change the setting using **h** or **m**. The symbol on the sub-display will flash.



- ③ Press **WRITE** to confirm the setting. (The symbol on the sub-display will change from flashing to lighting.)

#### «Note»

- If summer time adjustment is set to "Auto" (automatic adjustment), **+1h** will be ignored.
- To leave initial setting mode, press **TIME ADJ** for 3 s or more to leave the initial setting mode.
- If **TIME ADJ** is pressed again before confirming the setting, the setting is cancelled.

# 6-6-7. F7: Summer Time Schedule Selection

Yearly  
2 chnls

Yearly  
4 chnls

The time and date when the Time Switch automatically switches to and from summer time can be selected with reference to the following regions.

## ◆Parameters

Regions	Summer time start date and time	Summer time end date and time
<b>US</b> (North America)	At 2:00 of the second Sunday in March	At 2:00 of the first Sunday in November
<b>EU</b> (Europe)	At 2:00 of the last Sunday in March	At 3:00 of the last Sunday in October
<b>RU5t</b> (Australia)	At 2:00 of the last Sunday in October	At 3:00 of the last Sunday in March

※ **The inverted character** indicates the default.

## ◆Setting

The setting is made in F7 (summer time schedule) of initial setting mode.

- Press **TIME ADJ** for 3 s or more in program setting mode to enter initial setting mode. Give short presses on **TIME ADJ** and move to the F7 display.

The    color indicates flashing.

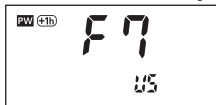

- Select one of the regions using **h** or **m**. (The symbol on the sub-display will flash.)

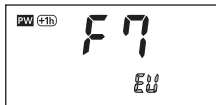

- Press **WRITE** to confirm the setting. (The symbol on the sub-display will change from flashing to lighting.)

### «Note»

- F7 is displayed only when summer time adjustment (F6) is set to "RU5t".
- To leave initial setting mode, press **TIME ADJ** for 3 s or more.
- If **TIME ADJ** is pressed again before confirming the setting, the setting is cancelled.

# 6-6-8. F8: Season Switching

Yearly  
2 chnls

Yearly  
4 chnls

Programs can be automatically switched according to the set seasons.

## ◆Parameters

**OFF** : No switching

**ON** : Automatic switching (Specify the period in F9.)

※ **The inverted character** indicates the default.

## ◆Setting

The setting is made in F8 (season switching) of initial setting mode.

- ① Press **TIME ADJ** for 3 s or more in program setting mode to enter initial setting mode. Give short presses on **TIME ADJ** and move to the F8 display.

- ② Change the setting using **h** or **m**. (The symbol on the sub-display will flash.)

- ③ Press **WRITE** to confirm the setting. (The symbol on the sub-display will change from flashing to lighting.)

The  color indicates flashing.



※ "C" and "D" are not displayed in the 2 channel type.

## «Note»

- When this function is set to ON, the number of programmable steps is changed. (Refer to "Section 4. Ratings and characteristics" in the Installation.)
- If the setting is changed between ON and OFF, all the set weekly programs will be cleared.
- This function switches weekly programs but not yearly programs.
- To leave initial setting mode, press **TIME ADJ** for 3 s or more.



# 6-6-9. F9: Period of Season

Yearly  
2 chnls

Yearly  
4 chnls

The date on which the Time Switch automatically switches programs can be set.

## ◆ Setting

The setting is made in F9 (period of season) of initial setting mode.

- ① Press **[TIME ADJ]** for 3 s or more in program setting mode to enter initial setting mode. Give short presses on **[TIME ADJ]** and move to the F9 display.

- ② Select a season from A to D to set the period of a season using **[h]** or **[m]**.

- ③ Press **[WRITE]** to confirm the setting and specify the start date with **[M]** and **[D]**. ※

- ④ Press **[WRITE]** Key and specify the end date with **[M]** and **[D]**. ※

- ⑤ Press **[WRITE]** to confirm the setting. (After **[WRITE]** is pressed, another season can be set.)

- ※ Holding down these Keys rapidly advances the value. Pressing **[▽]** decrements the value of the Key that was last pressed.

The  color indicates flashing.

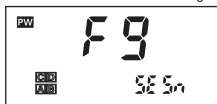

※ "C" and "D" are not displayed in the 2 channel type.

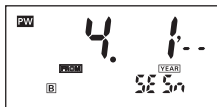
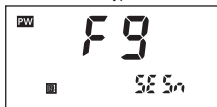

## ◀Note▶

- The default is as follows.

A : 1. 1 to 12.31 (Jan/01 to Dec/ 31)

B to D : --.-- to --.-- (not specified) ※ "C" and "D" are not displayed in the 2 channel type.

- If the set periods are overlapped, the priority is increased in the following order. A→B→C→D

<Example>Setting : A(January 1 to December 31), B(April 1 to September 30)

Performance : A(January 1 to March 31), B(April 1 to September 30), A(October 1 to December 31)

- The year cannot be specified.
- On a leap-year day, February 29, the Time Switch performs the same operation as that of February 28.
- If **period setting** is not required, set the parameter to --.--.
- If **[TIME ADJ]** is pressed again before confirming the setting, the setting is cancelled.
- To leave initial setting mode, press **[TIME ADJ]** for 3 s or more.

## 7. Operation while the Power Supply is OFF

Weekly  
2 chnls

Yearly  
2 chnls

Yearly  
4 chnls

The display can be activated even when the power is OFF.  
The current time can be displayed and settings can be made.

- While power is OFF, output as well as the output indicator and the power indicator are turned OFF.
- If no key input is entered within 2 min or more, the display is automatically turned off. To activate the display, press any Key for 1 s or more.  
※Except for slide switches and DIP switches.
- A next operation is not displayed during the power off.
- Override and automatic return operation is not available.



## 8. Resetting

Weekly  
2 chnls

Yearly  
2 chnls

Yearly  
4 chnls

All the set data including the current time can be reset (initialized).

- Resetting is possible in any mode from run mode to setting mode.

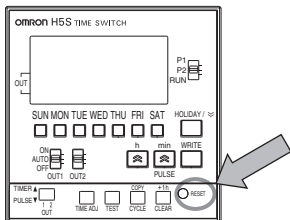

<Diagram with the front cover open>

# 9. Time Accuracy

Weekly  
2 chnls

Yearly  
2 chnls

Yearly  
4 chnls

<Standard model> ... Models without "-X" in final letter of model number

Time accuracy is adjusted to  $\pm 15$  s/month at an ambient temperature of 25°C before delivery. Nevertheless, as time accuracy is influenced by ambient temperature whether it is high or low, inaccuracy may occur. For example, if the product is used at ambient temperatures of over 50°C or under 0°C, there may be an inaccuracy of more than 60 s/month.

<Temperature compensation model> ... Models with "-X" in final letter of model number .

The Time Switch carries the circuits to manage time accuracy against temperature change. This model provides highly accurate time measurement in a broad temperature range as shown below.

$\pm 15$  s/month ... at ambient temperatures of -10 to 45 °C

$\pm 20$  s/month ... at ambient temperatures of 45 to 55 °C

# 10. Displayed Symbols

Weekly  
2 chnls

Yearly  
2 chnls

Yearly  
4 chnls

The following symbols are displayed by operations in run mode and program setting mode.

Displayed symbols	Name	Meaning	Section
HdRY	HDAY (Holiday)	Holiday setting mode	5-1
tESt	TEST (Test)	Program check function	5-2
CLR	CLR (Clear)	Clearing the settings	4-9
StEP	STEP (Step)	Clearing a part of settings	4-9
ALL	ALL (All)	Clearing all the settings	4-9
COpy	COPY (Copy)	Day override operation	5-4
CHEC	CHEC (Check)	Checking the settings	5-3
HOuR	HOUR (Hour)	Total time display	6-1
CNT	CNT (Count)	Total count display	6-1

# 11. Troubleshooting

Weekly  
2 chnls

Yearly  
2 chnls

Yearly  
4 chnls

## ◆ Self-check function

When an error occurs, the following error codes are displayed.

Error code	Meaning	Output	Countermeasures
E1	CPU error	OFF	Press <b>RESET</b> .
E2	Memory error	OFF	Press <b>RESET</b> .

## ◆ Troubleshooting

If there is a problem with the Time Switch, check the following items.

Problems	Check items	Section
The Time Switch does not operate when the power is turned ON.	Is the power actually ON? Check that the <b>PW</b> indicator is turned ON.	<Operation>2
The Time Switch does not operate according to the settings.	Is the Time Switch wired correctly? Check the wiring.	<Installation>2,3
	Is the OUT ON/OFF switch set to AUTO?	<Operation>2
	Is the Time Switch set correctly?	<Operation>4
	Isn't the Time Switch set for holiday operation?	<Operation>5-1
	Isn't the Time Switch set for override and automatic return operation?	<Operation>5-8
	Isn't the Time Switch set for day override operation? (Weekly type only)	<Operation>5-4
	Isn't the Time Switch set for yearly operation? (Yearly types only)	<Operation>4-6
Output does not turned ON when the OUT ON/OFF switch is set to ON.	Are banks (weekly type only) or seasons (yearly types only) set correctly?	<Operation>6-4 <Operation>6-5
	Is the power actually ON? Check that the <b>PW</b> indicator is turned ON.	<Operation>2
The time is fast or slow.	The time accuracy is influenced by the ambient temperature. Correct the present time in time adjustment mode.	<Operation>9 <Operation>3
	Is the Time Switch installed in a location subject to excessive noise? Timing performance may be adversely affected if the Time Switch is installed in a location subject to excessive noise. Separate the Time Switch from any sources of noise.	—
The display does not appear.	If no Key input is entered within 2 minutes with the power OFF, the display is turned OFF. The built-in battery may be exhausted. Please contact the dealer from which you purchased the product.	<Operation>7
The display is incorrect.	The Time Switch may be affected by noise or surge. Separate the Time Switch from any sources of noise. The built-in battery may be exhausted. Please contact the dealer from which you purchased the product.	—
There is a black spot on the LCD display's surface.	Black spot may appear due to static electricity. The spot disappears after a while.	—
The set value is not retained.	The built-in battery may be exhausted. Please contact the dealer from which you purchased the product.	—

# Installation

## 1. Dimensions and Mounting Dimensions

### H5S-□B□ (Flush-mounting Model)

(Unit: mm)

#### ● Dimensions

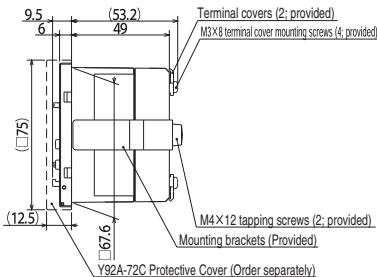
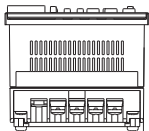
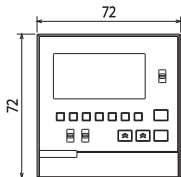

※ Terminal screw size : M3.5

※ This diagram shows a 2 channel type. A 4 channel type has the same external dimensions.

#### ● Mounting Dimensions

##### Panel Cutout (DIN43700 compliant)

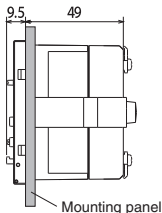
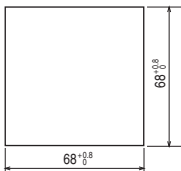

Note. The recommended panel thickness is 1 to 5 mm.

# H5S-□FB□ (Surface-mounting model) (Unit: mm)

## ● Dimensions

<With the provided small terminal covers>

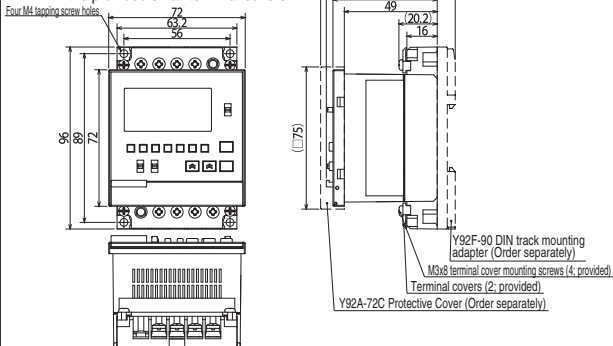

<With the optional large terminal cover>

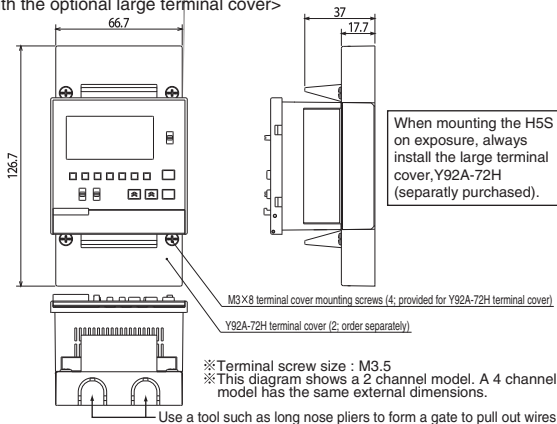

# ■ H5S-□FB□ (Surface-mounting model) (Unit: mm)

## ● Mounting Dimensions

<Surface mounting>

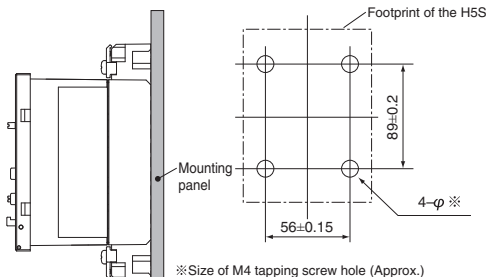

※ Size of M4 tapping screw hole (Approx.)

Panel thickness t	0.8 to 1.2	1.6 to 4
Diameter of the mounting hole	φ3.6	φ3.7

<DIN track mounting>

※ Y92F-90 DIN track mounting adapter (separately purchased) must be installed.

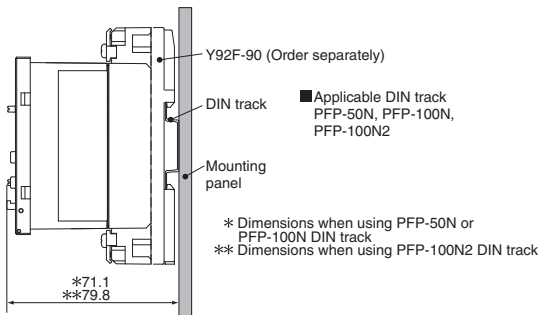

# 2. Connections

## ● Flush-mounting Model (H5S-□B□)

<2 channel type>

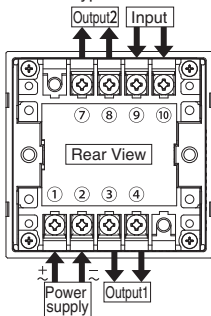

<4 channel type>

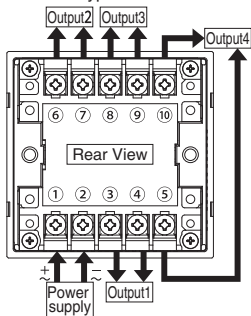

## ● Surface-mounting Model (H5S-□FB□)

<2 channel type>

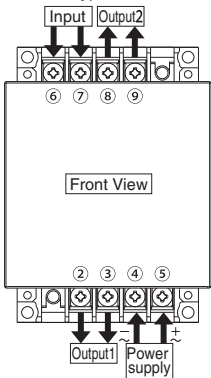

<4 channel type>

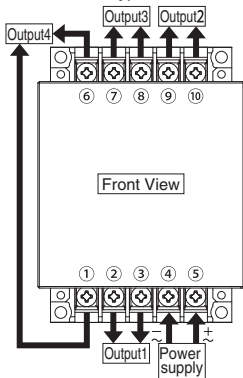



# 3. Wiring

Read the following information before performing wiring.

## <Output>

- The Time Switch output is no-voltage contact output. A power supply must be provided to drive the load. Perform wiring according to the information on the next page.
- Output contact rating is different between 2 channel and 4 channel types. (☞ Installation 4, 5)
- When driving an inductive load (e.g., coil), a surge voltage is generated when the contacts (i.e., Time Switch output) are switched, and in some cases this may damage other devices connected to the Time Switch or the same line. Absorb the surge with a capacitor (C) and resistor (R) as shown in the following diagram.

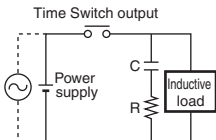

As a rough guide, the capacitor (C) and resistor (R) should have the following specifications:

C: 0.5 to 1  $\mu\text{F}$  for a switching current of 1 A

R: 0.5 to 1  $\Omega$  for a switching voltage of 1 V

- Use a capacitor with a dielectric strength appropriate for the power supply voltage. Use an AC-type capacitor with AC circuits.

There may be cases where, due to inconsistencies in the nature and characteristics of the load, delays in restoring the load may cause problems. Be sure to confirm that correct operation is possible under the actual operating conditions.

## <Input> ※2 channel type only

- Use a contact input such as a switch or relay. (Use a high-reliability contact capable of making and breaking 0.1 mA at 5 V)

## <Wiring>

- Applicable tightening torque : 0.98 to 1.17 N·m
- Do not connect more than two crimp terminals to each Time Switch terminal.
- Up to two wires of the same size and type can be inserted into a single terminals.
- When using solid wires, strip them as shown in the right hand diagram.
- Applicable wire for wiring is as follows:  
600V vinyl-insulated wire with a gage of AWG 22 to AWG 14 (equal to a cross-sectional area of 0.326 to 2.081  $\text{mm}^2$ )  
Solid wire or twisted wire  
Copper

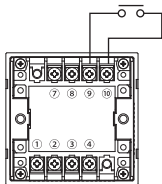

※Wiring when using  
Flush-mounting Model

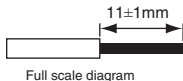

## ● Separate Power Supplies for Time Switch and Load

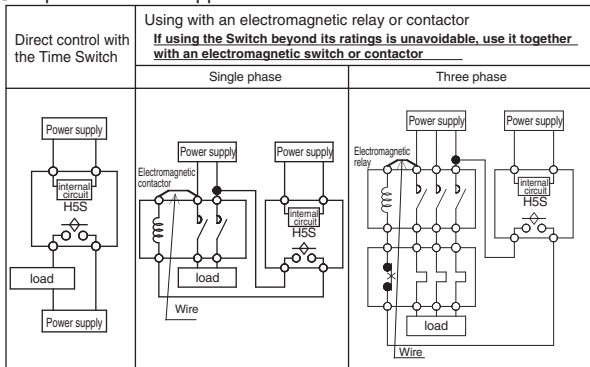

## ● Common Power Supply for Time Switch and Load

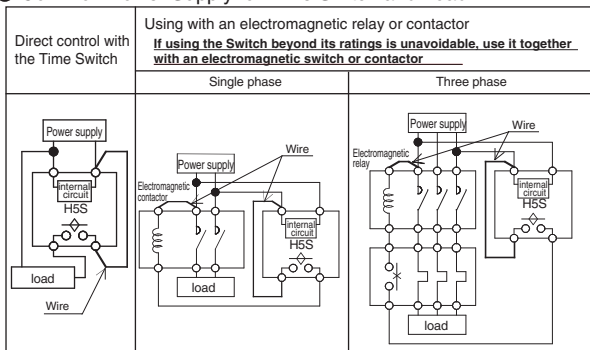

■ Recommended fuse : T2A, 250 VAC, time delay, low breaking capacity

# 4. Ratings and Characteristics

		Weekly 2 chnls H5S-WB2(D) H5S-WFB2(D)	Yearly 2 chnls H5S-YB2(D)-X H5S-YFB2(D)-X	Yearly 4 chnls H5S-YB4(D)-X H5S-YFB4(D)-X
Supply voltage		100 to 240 VAC 50/60 Hz : Models without "D" in model number 24 VDC : Models with "D" in model number		
Operating voltage range		85 to 110% of rated voltage (AC) 85 to 120% of rated voltage (DC)		
Power consumption (*1)		Approx. 2.9 VA (AC) Approx. 0.8 W (DC)	Approx. 3.2 VA (AC) Approx. 0.9 W (DC)	Approx. 3.5 VA (AC) Approx. 1.0 W (DC)
Control output	Number of circuits	SPST-NO X 2 circuits (independent)		SPST-NO X 4 circuit (independent)
	Circuit	Separated from power circuit (no-voltage)		
Capacity	Resistive (cosφ=1)	15 A, 250 VAC (*2)		3A, 250VAC
	Inductive	10 A, 250 VAC (cosφ=0.7)		2A, 250VAC (cosφ=0.4)
Ambient operating temperature		-10 to 55 °C (with no icing or condensation)		
Ambient operating humidity		25 to 85% (with no icing or condensation)		
Storage temperature		-25 to 65 °C (with no icing or condensation)		
Total error (*3)		±0.01% ±0.05s max.		
Cyclic error (*4)		±15s per month (at 25 °C)	±15s per month (at -10 to 45 °C)	
Memory protection		5 years min. (at 25 °C)		
Weight		Approx. 200 g		
Operations	Cycle length	1 week	1 year (with the built-in calendar to year 2099)	
	Minimum cycle length	1 min		
	Pulse width	1 to 59 s (in seconds) or 1 to 60 min (in minutes)		
	Weekly programs (*5)	40 steps/chnl	48 steps/chnl (*6) 24 steps/chnl (*7)	48 steps/chnl (*6) 12 steps/chnl (*7)
	Yearly program capacity	—	16 steps (4 times)/chnl	16 steps (4 times)/chnl
	Yearly holiday setting capacity	—	16 times	16 times
Installation environment		Over-voltage Category II, pollution degree 2 (as per IEC61010-1)		
Altitude		2,000 m max.		
Vibration	Mechanical durability	10 to 55 Hz, 0.75 mm double amplitude		
	Malfunction durability	10 to 55 Hz, 0.25 mm double amplitude		
Shock	Mechanical durability	300m/s <sup>2</sup>		
	Malfunction durability	100m/s <sup>2</sup>		
Approvals		cURus UL 508 / CSA C 22.2 No.14 EN60730-2-7 VDE0106/part100		

\*1 At 264 VAC, 60Hz for AC-type or 28.8 VDC for DC-type

\*2 A current of 15 A can be passed through each output.  
The current as sum of 2 outputs varies depending on the ambient air temperature. The right hand diagram shows the derating curve.

\*3 The total error including the repeat accuracy, setting error, variation due to voltage change, and variation due to temperature change is ±0.01%±0.05 s max.

\*4 Refer to "9. Time accuracy" in the Operation.

\*5 Number of steps used for each weekly operation is as shown below.

- Timer operation: 2 steps
- Pulse-output operation : 1 step
- Cyclic operation: 4 steps

\*6 Program capacity when no season is set :  Section 6-5 in the Operation

\*7 Program capacity when seasons are set :  Section 6-5 in the Operation

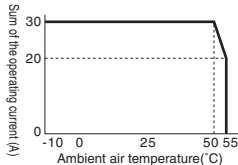

## 5. Output (Built-in Relay) Life Expectancy

<2 channel type>

- Mechanical life expectancy at 20°C 100,000 operations min.
- Electrical life expectancy at 20°C
  - 50,000 operations min. for a resistive load of 15 A at 250 VAC
  - 50,000 operations min. for a resistive load of 10 A at 30 VDC
  - 50,000 operations min. for an inductive load ( $\cos\phi = 0.7$ ) of 10 A at 250 VAC
  - 50,000 operations min. for a motor load of 1 HP at 250 VAC
  - 50,000 operations min. for a lamp load of 100 W at 100 VAC
  - 10,000 operations min. for a lamp load of 300 W at 100 VAC

<4 channel type>

- Mechanical life expectancy at 20°C 100,000 operations min.
- Electrical life expectancy at 20°C
  - 50,000 operations min. for a resistive load of 3 A at 250 VAC
  - 50,000 operations min. for a resistive load of 3 A at 30 VDC

## 6. EN/IEC Standards

- The insulation system between the power supply circuit and output terminals provides basic insulation.  
Therefore connect the output terminals only to circuits without accessible conductive parts. If a connection to Safety Extra Low-Voltage (SELV) circuits is desired, supplementary insulation must be provided.
- Use crimp type cable lug terminals with insulating sleeves for wiring.
- Be sure to mount a surface-mounting model (H5S-□FB□) in an enclosure.
- The derating curve shows the load current as a sum of both outputs [A] vs. the ambient air temperature [°C] of 2 channel types.

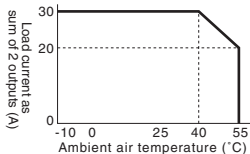

If wires with a temperature rating of 105 °C or higher are used, see the derating curve in the Section 4, "Ratings and characteristics".

- Control system :Electronic
- Types of automatic operation :Weekly models - Type 1BSTU  
Yearly models - Type 2BSTU
- Protective class :Class 0
- Rated impulse withstand voltage :2500V AC
- Ball-pressure test temperature (enclosure material) :125°C

# 7. Accessories and Repair Parts

## ■ Protective cover

Y92A-72C

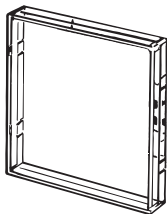

## ■ DIN track mounting adapter

Y92F-90



※ Only for H5S-□FB□ model  
(Surface-mounting model)

## ■ Large terminal cover

Y92A-72H (in pairs)

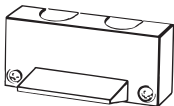

※ Only for H5S-□FB□ model  
(Surface-mounting model)

# 8. Record of Settings

Use the following chart to record important settings.

Weekly timer operation

Output No.	Bank:																																										
	<table border="1"> <thead> <tr> <th>ON Time</th> <th>OFF Time</th> </tr> </thead> <tbody> <tr> <td>SUN MON TUE WED THU FRI SAT</td> <td>SUN MON TUE WED THU FRI SAT</td> </tr> <tr> <td>10:30</td> <td>19:00</td> </tr> <tr> <td>SUN MON TUE WED THU FRI SAT</td> <td>SUN MON TUE WED THU FRI SAT</td> </tr> <tr> <td>:</td> <td>:</td> </tr> <tr> <td>SUN MON TUE WED THU FRI SAT</td> <td>SUN MON TUE WED THU FRI SAT</td> </tr> <tr> <td>:</td> <td>:</td> </tr> <tr> <td>SUN MON TUE WED THU FRI SAT</td> <td>SUN MON TUE WED THU FRI SAT</td> </tr> <tr> <td>:</td> <td>:</td> </tr> <tr> <td>SUN MON TUE WED THU FRI SAT</td> <td>SUN MON TUE WED THU FRI SAT</td> </tr> <tr> <td>:</td> <td>:</td> </tr> <tr> <td>SUN MON TUE WED THU FRI SAT</td> <td>SUN MON TUE WED THU FRI SAT</td> </tr> <tr> <td>:</td> <td>:</td> </tr> <tr> <td>SUN MON TUE WED THU FRI SAT</td> <td>SUN MON TUE WED THU FRI SAT</td> </tr> <tr> <td>:</td> <td>:</td> </tr> <tr> <td>SUN MON TUE WED THU FRI SAT</td> <td>SUN MON TUE WED THU FRI SAT</td> </tr> <tr> <td>:</td> <td>:</td> </tr> <tr> <td>SUN MON TUE WED THU FRI SAT</td> <td>SUN MON TUE WED THU FRI SAT</td> </tr> <tr> <td>:</td> <td>:</td> </tr> <tr> <td>SUN MON TUE WED THU FRI SAT</td> <td>SUN MON TUE WED THU FRI SAT</td> </tr> <tr> <td>:</td> <td>:</td> </tr> </tbody> </table>	ON Time	OFF Time	SUN MON TUE WED THU FRI SAT	SUN MON TUE WED THU FRI SAT	10:30	19:00	SUN MON TUE WED THU FRI SAT	SUN MON TUE WED THU FRI SAT	:	:	SUN MON TUE WED THU FRI SAT	SUN MON TUE WED THU FRI SAT	:	:	SUN MON TUE WED THU FRI SAT	SUN MON TUE WED THU FRI SAT	:	:	SUN MON TUE WED THU FRI SAT	SUN MON TUE WED THU FRI SAT	:	:	SUN MON TUE WED THU FRI SAT	SUN MON TUE WED THU FRI SAT	:	:	SUN MON TUE WED THU FRI SAT	SUN MON TUE WED THU FRI SAT	:	:	SUN MON TUE WED THU FRI SAT	SUN MON TUE WED THU FRI SAT	:	:	SUN MON TUE WED THU FRI SAT	SUN MON TUE WED THU FRI SAT	:	:	SUN MON TUE WED THU FRI SAT	SUN MON TUE WED THU FRI SAT	:	:
ON Time	OFF Time																																										
SUN MON TUE WED THU FRI SAT	SUN MON TUE WED THU FRI SAT																																										
10:30	19:00																																										
SUN MON TUE WED THU FRI SAT	SUN MON TUE WED THU FRI SAT																																										
:	:																																										
SUN MON TUE WED THU FRI SAT	SUN MON TUE WED THU FRI SAT																																										
:	:																																										
SUN MON TUE WED THU FRI SAT	SUN MON TUE WED THU FRI SAT																																										
:	:																																										
SUN MON TUE WED THU FRI SAT	SUN MON TUE WED THU FRI SAT																																										
:	:																																										
SUN MON TUE WED THU FRI SAT	SUN MON TUE WED THU FRI SAT																																										
:	:																																										
SUN MON TUE WED THU FRI SAT	SUN MON TUE WED THU FRI SAT																																										
:	:																																										
SUN MON TUE WED THU FRI SAT	SUN MON TUE WED THU FRI SAT																																										
:	:																																										
SUN MON TUE WED THU FRI SAT	SUN MON TUE WED THU FRI SAT																																										
:	:																																										
SUN MON TUE WED THU FRI SAT	SUN MON TUE WED THU FRI SAT																																										
:	:																																										

Weekly pulse-output operation

Output No.	Bank:																																								
	<table border="1"> <thead> <tr> <th>ON Time</th> <th>Pulse width</th> </tr> </thead> <tbody> <tr> <td>SUN MON TUE WED THU FRI SAT</td> <td>30 s</td> </tr> <tr> <td>SUN MON TUE WED THU FRI SAT</td> <td></td> </tr> <tr> <td>:</td> <td></td> </tr> <tr> <td>SUN MON TUE WED THU FRI SAT</td> <td></td> </tr> <tr> <td>:</td> <td></td> </tr> <tr> <td>SUN MON TUE WED THU FRI SAT</td> <td></td> </tr> <tr> <td>:</td> <td></td> </tr> <tr> <td>SUN MON TUE WED THU FRI SAT</td> <td></td> </tr> <tr> <td>:</td> <td></td> </tr> <tr> <td>SUN MON TUE WED THU FRI SAT</td> <td></td> </tr> <tr> <td>:</td> <td></td> </tr> <tr> <td>SUN MON TUE WED THU FRI SAT</td> <td></td> </tr> <tr> <td>:</td> <td></td> </tr> <tr> <td>SUN MON TUE WED THU FRI SAT</td> <td></td> </tr> <tr> <td>:</td> <td></td> </tr> <tr> <td>SUN MON TUE WED THU FRI SAT</td> <td></td> </tr> <tr> <td>:</td> <td></td> </tr> <tr> <td>SUN MON TUE WED THU FRI SAT</td> <td></td> </tr> <tr> <td>:</td> <td></td> </tr> </tbody> </table>	ON Time	Pulse width	SUN MON TUE WED THU FRI SAT	30 s	SUN MON TUE WED THU FRI SAT		:		SUN MON TUE WED THU FRI SAT		:		SUN MON TUE WED THU FRI SAT		:		SUN MON TUE WED THU FRI SAT		:		SUN MON TUE WED THU FRI SAT		:		SUN MON TUE WED THU FRI SAT		:		SUN MON TUE WED THU FRI SAT		:		SUN MON TUE WED THU FRI SAT		:		SUN MON TUE WED THU FRI SAT		:	
ON Time	Pulse width																																								
SUN MON TUE WED THU FRI SAT	30 s																																								
SUN MON TUE WED THU FRI SAT																																									
:																																									
SUN MON TUE WED THU FRI SAT																																									
:																																									
SUN MON TUE WED THU FRI SAT																																									
:																																									
SUN MON TUE WED THU FRI SAT																																									
:																																									
SUN MON TUE WED THU FRI SAT																																									
:																																									
SUN MON TUE WED THU FRI SAT																																									
:																																									
SUN MON TUE WED THU FRI SAT																																									
:																																									
SUN MON TUE WED THU FRI SAT																																									
:																																									
SUN MON TUE WED THU FRI SAT																																									
:																																									

Weekly Cyclic operation

Output No.	Bank:																																												
	<table border="1"> <thead> <tr> <th>Start Time</th> <th>Stop Time</th> <th>ON width</th> <th>OFF width</th> </tr> </thead> <tbody> <tr> <td>SUN MON TUE WED THU FRI SAT</td> <td>SUN MON TUE WED THU FRI SAT</td> <td>5 min.</td> <td>25 min.</td> </tr> <tr> <td>10:30</td> <td>19:00</td> <td></td> <td></td> </tr> <tr> <td>SUN MON TUE WED THU FRI SAT</td> <td>SUN MON TUE WED THU FRI SAT</td> <td></td> <td></td> </tr> <tr> <td>:</td> <td>:</td> <td></td> <td></td> </tr> <tr> <td>SUN MON TUE WED THU FRI SAT</td> <td>SUN MON TUE WED THU FRI SAT</td> <td></td> <td></td> </tr> <tr> <td>:</td> <td>:</td> <td></td> <td></td> </tr> <tr> <td>SUN MON TUE WED THU FRI SAT</td> <td>SUN MON TUE WED THU FRI SAT</td> <td></td> <td></td> </tr> <tr> <td>:</td> <td>:</td> <td></td> <td></td> </tr> <tr> <td>SUN MON TUE WED THU FRI SAT</td> <td>SUN MON TUE WED THU FRI SAT</td> <td></td> <td></td> </tr> <tr> <td>:</td> <td>:</td> <td></td> <td></td> </tr> </tbody> </table>	Start Time	Stop Time	ON width	OFF width	SUN MON TUE WED THU FRI SAT	SUN MON TUE WED THU FRI SAT	5 min.	25 min.	10:30	19:00			SUN MON TUE WED THU FRI SAT	SUN MON TUE WED THU FRI SAT			:	:			SUN MON TUE WED THU FRI SAT	SUN MON TUE WED THU FRI SAT			:	:			SUN MON TUE WED THU FRI SAT	SUN MON TUE WED THU FRI SAT			:	:			SUN MON TUE WED THU FRI SAT	SUN MON TUE WED THU FRI SAT			:	:		
Start Time	Stop Time	ON width	OFF width																																										
SUN MON TUE WED THU FRI SAT	SUN MON TUE WED THU FRI SAT	5 min.	25 min.																																										
10:30	19:00																																												
SUN MON TUE WED THU FRI SAT	SUN MON TUE WED THU FRI SAT																																												
:	:																																												
SUN MON TUE WED THU FRI SAT	SUN MON TUE WED THU FRI SAT																																												
:	:																																												
SUN MON TUE WED THU FRI SAT	SUN MON TUE WED THU FRI SAT																																												
:	:																																												
SUN MON TUE WED THU FRI SAT	SUN MON TUE WED THU FRI SAT																																												
:	:																																												



**OMRON Corporation    Industrial Automation Company**  
Tokyo, JAPAN

**Contact: [www.ia.omron.com](http://www.ia.omron.com)**

***Regional Headquarters***

**OMRON EUROPE B.V.**

Wegalaan 67-69-2132 JD Hoofddorp

The Netherlands

Tel: (31)2356-81-300/Fax: (31)2356-81-388

**OMRON ASIA PACIFIC PTE. LTD.**

No. 438A Alexandra Road # 05-05/08

(Lobby 2), Alexandra Technopark,

Singapore 119967

Tel: (65) 6835-3011/Fax: (65) 6835-2711

**OMRON ELECTRONICS LLC**

One Commerce Drive Schaumburg,

IL 60173-5302 U.S.A.

Tel: (1) 847-843-7900/Fax: (1) 847-843-7787

**OMRON (CHINA) CO., LTD.**

Room 2211, Bank of China Tower,

200 Yin Cheng Zhong Road,

PuDong New Area, Shanghai, 200120, China

Tel: (86) 21-5037-2222/Fax: (86) 21-5037-2200