

C200HW-PRT21



PROFIBUS-DP Slave Unit

Operation Manual

Produced February 2000

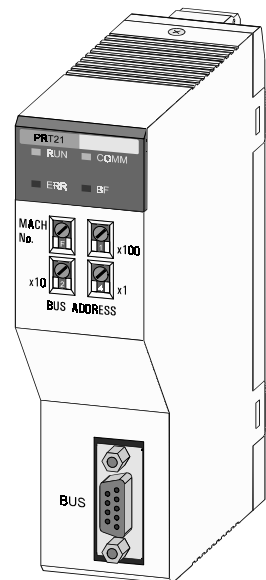

Notice:

OMRON products are manufactured for use according to proper procedures by a qualified operator and only for the purposes described in this manual.

The following conventions are used to indicate and classify precautions in this manual. Always consult the information provided with them. Failure to heed precautions can result in injury to people or damage to the product.

 **DANGER** Indicates information that, if not heeded, is likely to result in loss of life or serious injury.

 **WARNING** Indicates information that, if not heeded, could possibly result in loss of life or serious injury.

 **Caution** Indicates a potentially hazardous situation which, if not avoided, may result in minor or moderate injury, or property damage.

OMRON Product References

All OMRON products are capitalised in this manual. The word “Unit” is also capitalised when it refers to an OMRON product, regardless of whether or not it appears in the proper name of the product.

The abbreviation “Ch”, which appears in some displays and on some OMRON products, often means “word” and is abbreviated “Wd” in documentation in this sense.

The abbreviation “PLC” means Programmable Logic Controller and is not used as an abbreviation for anything else.

Visual Aids

The following headings appear in the left column of the manual to help you locate different types of information.

Note Indicates information of particular interest for efficient and convenient operation of the product.

1, 2, 3... Indicates lists of one sort or another, such as procedures, checklists, etc.

© OMRON, 2000

All rights reserved. No part of this publication may be reproduced, stored in a retrieval system, or transmitted, in any form, or by any means, mechanical, electronic, photocopying, recording, or otherwise, without the prior written permission of OMRON.

No patent liability is assumed with respect to the use of the information contained herein. Moreover, because OMRON is constantly striving to improve its high-quality products, the information contained in this manual is subject to change without notice. Every precaution has been taken in the preparation of this manual. Nevertheless, OMRON assumes no responsibility for errors or omissions. Neither is any liability assumed for damages resulting from the use of the information contained in this publication.

TABLE OF CONTENTS

PRECAUTIONS	xi
1 Intended Audience	xii
2 General Precautions	xii
3 Safety Precautions	xii
4 Operating Environment Precautions	xiii
5 Application Precautions	xiv
6 EC Directives	xvi
SECTION 1	
PROFIBUS-DP	1
1-1 Introduction	2
1-2 Protocol architecture	3
1-3 Device types	4
1-4 PROFIBUS-DP characteristics	5
1-5 Device Data Base files	8
1-6 Profiles	8
SECTION 2	
SPECIFICATIONS AND PERFORMANCE	9
2-1 Overall Specifications	10
2-2 Dimensions	11
2-3 Performance	12
SECTION 3	
INSTALLATION	15
3-1 Physical layout of the Unit	16
3-2 Mounting the C200HW-PRT21	19
3-3 Setting up a network	19
SECTION 4	
USER INTERFACE	25
4-1 Input and Output Data	26
4-2 Unit Settings	27
4-3 Control and status area	31
4-4 LEDs	38
SECTION 5	
TROUBLESHOOTING AND MAINTENANCE	39
5-1 Error Indicators	40
5-2 Troubleshooting	40
5-3 Maintenance	43
Appendices	
A CS1 PLC series compatibility	45
B GSD file for C200HW-PRT21	47
Index	51
Revision History	53

About this Manual:

This manual describes the installation and operation of the C200HW-PRT21 PROFIBUS-DP Slave Unit and includes the sections described below.

Please read this manual carefully and be sure you understand the information provided before attempting to install and operate the PROFIBUS-DP Slave Unit. **Be sure to read the precautions provided in the following section.**

Section 1 gives a brief description of PROFIBUS-DP.

Section 2 describes the installation of the C200HW-PRT21.

Section 3 describes the overall specifications and the communication performance of the Unit.

Section 4 describes the interface with the user.

Section 5 describes the troubleshooting procedures and maintenance operations.



WARNING Failure to read and understand the information provided in this manual may result in personal injury or death, damage to the product, or product failure. Please read each section in its entirety, and be sure you understand the information provided in the section and related sections before attempting any of the procedures or operations given.

PRECAUTIONS

This section provides general precautions for using the PROFIBUS-DP Slave Units, Programmable Controllers, and related devices.

The information contained in this section is important for the safe and reliable application of the PROFIBUS-DP Slave Units. You must read this section, and understand the information contained, before attempting to set up or operate a PROFIBUS-DP Slave Unit and PLC system.

1 Intended Audience	xii
2 General Precautions	xii
3 Safety Precautions	xii
4 Operating Environment Precautions	xiii
5 Application Precautions	xiv
6 EC Directives	xvi

1 Intended Audience

This manual is intended for the following personnel, who must also have knowledge of electrical systems (an electrical engineer or the equivalent).

- Personnel in charge of installing FA systems.
- Personnel in charge of designing FA systems.
- Personnel in charge of managing FA systems and facilities.

2 General Precautions

The user must operate the product according to the performance specifications described in the operation manuals.

Before using the product under conditions which are not described in the manual or applying the product to nuclear control systems, railroad systems, aviation systems, vehicles, combustion systems, medical equipment, amusement machines, safety equipment, and other systems, machines and equipment that may have a serious influence on lives and property if used improperly, consult your OMRON representative.

Make sure that the ratings and performance characteristics of the product are sufficient for the systems, machines, and equipment, and be sure to provide the systems, machines, and equipment with double safety mechanisms.

This manual provides information for installing and operating OMRON PROFIBUS-DP Slave Units. Be sure to read this manual before operation and keep this manual close at hand for reference during operation.

 **WARNING** It is extremely important that a PLC, and all PLC Units, be used for the specified purpose and under the specified conditions, especially in applications that can directly or indirectly affect human life. You must consult with your OMRON representative before applying a PLC system to the above mentioned applications.





3 Safety Precautions

 **WARNING** The CPU Unit refreshes I/O even when the program is stopped (i.e., even in PROGRAM mode). Confirm safety thoroughly in advance before changing the status of any part of memory allocated to I/O Units, Special I/O Units, or CPU Bus Units. Any changes to the data allocated to any Unit may result in unexpected operation of the loads connected to the Unit. Any of the following operation may result in changes to memory status.



- Transferring I/O memory data from a Programming Device to the CPU Unit.
- Changing present values in memory with a Programming Device.
- Force-setting/-resetting bits with a Programming Device.
- Transferring I/O memory files from a Memory Card or EM file memory to the CPU Unit.
- Transferring I/O memory from a host computer or from another PLC on a network.

 **WARNING** Do not attempt to take any Unit apart while the power is being supplied. Doing so may result in electric shock.

 **WARNING** Do not touch any of the terminals or terminal blocks while the power is being supplied. Doing so may result in electric shock.

-  **WARNING** Do not attempt to disassemble, repair, or modify any Units. Any attempt to do so may result in malfunction, fire, or electric shock.
-  **WARNING** Do not touch the Power Supply Unit while power is being supplied or immediately after power has been turned off. Doing so may result in electric shock.
-  **Caution** Execute online edit only after confirming that no adverse effects will be caused by extending the cycle time. Otherwise, the input signals may not be readable.
-  **Caution** Confirm safety at the destination node before transferring a program to another node or changing contents of the I/O memory area. Doing either of these without confirming safety may result in injury.
-  **Caution** Tighten the screws on the terminal block of the AC Power Supply Unit to the torque specified in the operation manual. Loose screws may result in burning or malfunction.

4 Operating Environment Precautions

-  **Caution** Do not operate the control system in the following locations:
- Locations subject to direct sunlight.
 - Locations subject to temperatures or humidity outside the range specified in the specifications.
 - Locations subject to condensation as the result of severe changes in temperature.
 - Locations subject to corrosive or flammable gases.
 - Locations subject to dust (especially iron dust) or salts.
 - Locations subject to exposure to water, oil, or chemicals.
 - Locations subject to shock or vibration.
-  **Caution** Take appropriate and sufficient countermeasures when installing systems in the following locations:
- Locations subject to static electricity or other forms of noise.
 - Locations subject to strong electromagnetic fields.
 - Locations subject to possible exposure to radioactivity.
 - Locations close to power supplies.
-  **Caution** The operating environment of the PLC System can have a large effect on the longevity and reliability of the system. Improper operating environments can lead to malfunction, failure, and other unforeseeable problems with the PLC System. Be sure that the operating environment is within the specified conditions at installation and remains within the specified conditions during the life of the system.

5 Application Precautions

Observe the following precautions when using the PROFIBUS-DP Slave Units or the PLC.

 **WARNING** Failure to abide by the following precautions could lead to serious or possibly fatal injury. Always heed these precautions.

- Always ground the system with 100 (or less when installing the system, to protect against electrical shock.
- Always turn off the power supply to the PLC before attempting any of the following. Performing any of the following with the power supply turned on may lead to electrical shock:
 - Mounting or removing any Units (e.g., I/O Units, CPU Unit, etc.) or memory cassettes.
 - Assembling any devices or racks.
 - Connecting or disconnecting any connectors, cables or wiring.
 - Setting DIP switches or rotary switches.

 **Caution** Failure to abide by the following precautions could lead to faulty operation of the PLC or the system, or could damage the PLC or PLC Units. Always heed these precautions.

- Fail-safe measures must be taken by the customer to ensure safety in the event of incorrect, missing, or abnormal signals caused by broken signal lines, momentary power interruptions, or other causes.
- Interlock circuits, limit circuits, and similar safety measures in external circuits (i.e., not in the Programmable Controller) must be provided by the customer.
- If the I/O Hold Bit is turned ON, the outputs from the PLC will not be turned OFF, and will maintain their previous status when the PLC is switched from RUN or MONITOR mode to PROGRAM mode. Make sure that the external loads will not produce dangerous conditions when this occurs. (When operation stops for a fatal error, including those produced with the FALS instruction, all outputs from Output Unit will be turned OFF, and only the internal output status will be maintained.)
- Use the Units only with the power supplies and voltages specified in the operation manuals. Other power supplies and voltages may damage the Units.
- Take appropriate measures to ensure that the specified power with the rated voltage and frequency is supplied. Be particularly careful in places where the power supply is unstable. An incorrect power supply may result in malfunction.
- Install external breakers and take other safety measures against short-circuiting in external wiring. Insufficient safety measures against short-circuiting may result in burning.
- Do not apply voltages exceeding the rated input voltage to Input Units. The Input Units may be destroyed.
- Do not apply voltages exceeding the maximum switching capacity to Output Units. The Output Units may be destroyed.
- Always disconnect the LG terminal when performing withstand voltage tests.
- Install the Units properly as specified in the operation manuals. Improper installation of the Units may result in malfunction.
- Be sure that all the mounting screws, terminal screws, and cable connector screws are tightened to the torque specified in the relevant manuals. Incorrect tightening torque may result in malfunction.

-  **Caution**
- Leave the label attached to the Unit when wiring. Removing the label may result in malfunction if foreign matter enters the Unit.
 - Remove the label after the completion of wiring to ensure proper heat dissipation. Leaving the label attached may result in malfunction.
 - Use crimp terminals for wiring. Do not connect bare stranded wires directly to terminals. Connection of bare stranded wires may result in burning.
 - Wire all connections correctly. Double-check all wiring and switch settings before turning on the power supply. Incorrect wiring may result in burning.
 - Mount Units only after checking terminal blocks and connectors completely.
 - Be sure that the terminal blocks, Memory Units, expansion cables, and other items with locking devices are properly locked into place. Improper locking may result in malfunction.
 - Check switch settings, the contents of the DM Area, and other preparations before starting operation. Starting operation without the proper settings or data may result in an unexpected operation.
 - Check the user program for proper execution before actually running it on the Unit. Not checking the program may result in an unexpected operation.
 - Confirm that no adverse effect will occur in the system before attempting any of the following. Not doing so may result in an unexpected operation.
 - Changing the operating mode of the PLC.
 - Force-setting/force-resetting any bit in memory.
 - Changing the present value of any word or any set value in memory.
 - Resume operation with a new CPU Unit only after transferring the contents of the DM Area, HR Area, and other data required for resuming operation to the new Unit. Not doing so may result in an unexpected operation.
 - Do not pull on the cables or bend the cables beyond their natural limit. Doing either of these may break the cables.
 - Do not place objects on top of the cables or other wiring lines. Doing so may break the cables.
 - When replacing parts, be sure to confirm that the rating of a new part is correct. Not doing so may result in malfunction or burning.
 - Before touching a Unit, be sure to first touch a grounded metallic object in order to discharge any static built-up. Not doing so may result in malfunction or damage.
 - Do not touch circuit boards or the components mounted to them with your bare hands. There are sharp leads and other parts on the boards that may cause injury if handled improperly.
 - Provide proper shielding when installing in the following locations:
 - Locations subject to static electricity or other sources of noise.
 - Locations subject to strong electromagnetic fields.
 - Locations subject to possible exposure to radiation.
 - Locations near power supply lines.
 - Do not attempt to take any Units apart, to repair any Units, or to modify any Units in any way.

6 EC Directives

6-1 Applicable Directives

- EMC Directives
- Low Voltage Directive

6-2 Concepts

EMC Directives

OMRON devices that comply with EC Directives also conform to the related EMC standards so that they can be more easily built into other devices or the overall machine. The actual products have been checked for conformity to EMC standards (see the following note). Whether the products conform to the standards in the system used by the customer, however, must be checked by the customer.

EMC-related performance of the OMRON devices that comply with EC Directives will vary depending on the configuration, wiring, and other conditions of the equipment or control panel on which the OMRON devices are installed. The customer must, therefore, perform the final check to confirm that devices and the overall machine conform to EMC standards.

Note Applicable EMC (Electromagnetic Compatibility) standards are as follows:

EMS (Electromagnetic Susceptibility): EN61131-2

EMI (Electromagnetic Interference): EN50081-2

(Radiated emission: 10-m regulations)

Low Voltage Directive

Always ensure that devices operating at voltages of 50 to 1,000 VAC, and 75 to 1,500 VDC meet the required safety standards for the PLC (EN61131-2).

6-3 Conformance to EC Directives

The C200H- and CS1-series PLCs comply with EC Directives. To ensure that the machine or device in which the PLC is used complies with EC Directives, the PLC must be installed as follows:

- 1, 2, 3...**
1. The PLC must be installed within a control panel.
 2. You must use reinforced insulation or double insulation for the DC power supplies used for the communications power supply and I/O power supplies.
 3. OMRON PLCs complying with EC Directives also conform to the Common Emission Standard (EN50081-2). Radiated emission characteristics (10-m regulations) may vary depending on the configuration of the control panel used, other devices connected to the control panel, wiring, and other conditions. You must therefore confirm that the overall machine or equipment complies with EC Directives.

SECTION 1

PROFIBUS-DP

This section gives a brief description of PROFIBUS-DP.

1-1	Introduction	2
1-2	Protocol architecture	3
1-3	Device types	4
1-4	PROFIBUS-DP characteristics	5
1-4-1	Bus Access Protocol	5
1-4-2	Data throughput	6
1-4-3	Diagnostics functions	6
1-4-4	Protection mechanisms	6
1-4-5	Network states	7
1-5	Device Data Base files	8
1-6	Profiles	8

1-1 Introduction



Standard EN50170

PROFIBUS (**PRO**cess **FI**eld**BUS**) is a vendor-independent, open fieldbus standard for a wide range of applications in manufacturing-, process-, and building automation. Vendor independence and openness are guaranteed by the PROFIBUS standard EN50170. With PROFIBUS, devices of different manufacturers can communicate without special interface adjustments.

The PROFIBUS family consists of three compatible versions:

High speed

PROFIBUS-DP

DP stands for **D**ecentralised **P**eriphery. It is optimised for high speed and low-cost interfacing, especially designed for communication between automation control systems and distributed I/O at the device level.

Process Automation

PROFIBUS-PA

PA stands for **P**rocess **A**utomation. It permits sensors and actuators to be connected on one common bus line even in intrinsically-safe areas. It permits data communication and power supply over the bus using 2-wire technology according to the international standard IEC 1158-2.

Higher level

PROFIBUS-FMS

FMS stands for **F**ieldbus **M**essage **S**pecification. This version is a general-purpose solution for communication tasks at a higher level. Powerful services open up a wide range of applications and provide great flexibility. It can also be used for extensive and complex communications tasks.

Uniform bus access protocol

PROFIBUS-DP and PROFIBUS-FMS use the same transmission technology and a uniform bus access protocol. Thus, both versions can be operated simultaneously on the same cable. However, FMS field devices cannot be controlled by DP masters or vice versa.



Caution

It is not possible to exchange one of these family members by another family member. This will cause faulty operation.

The remainder of this Operation Manual only describes PROFIBUS-DP.

1-2 Protocol architecture

OSI reference model

The PROFIBUS protocol architecture is based on the Open System Interconnection (OSI) reference model in accordance with the international standard ISO 7498.

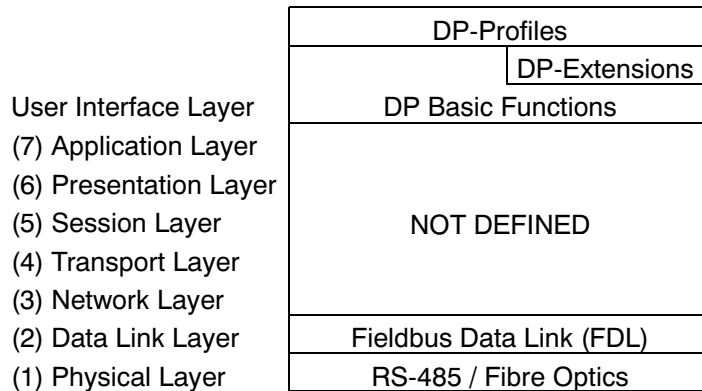

Figure 1. OSI layer model of PROFIBUS-DP

Layer 1, 2 and user interface

PROFIBUS-DP uses layers 1 and 2, and the user interface. Layers 3 to 7 are not defined.

Layer 1 (physical layer) defines the physical transmission characteristics.

Layer 2 (data link layer) defines the bus access protocol.

This streamlined architecture ensures fast and efficient data transmission. The application functions, which are available to the user, as well as the system and device behaviour of the various PROFIBUS-DP device types, are specified in the user interface.

Transmission medium

RS-485 transmission technology or fibre optics are defined as transmission media. RS-485 transmission is the most frequently used transmission technology. Its application area includes all areas in which high transmission speed and simple inexpensive installation are required. Twisted pair shielded copper cable with one conductor pair is used.

Easy installation

The RS-485 transmission technology is very easy to handle. Installation of the twisted pair cable does not require expert knowledge. The bus structure permits addition and removal of stations or step-by-step commissioning of the system without influencing the other stations. Later expansions have no effect on stations which are already in operation.

Various transmission speeds between 9.6 kbit/s and 12 Mbit/s can be selected. One unique transmission speed is selected for all devices on the bus when the system is commissioned.

Cable length

The maximum cable length depends on the transmission speed (see Section 3-3-1). The length can be increased by the use of repeaters. The use of more than 3 repeaters in series is not recommended.

1-3 Device types

PROFIBUS distinguishes between master devices and slave devices.

Master devices

Master devices determine the data communication on the bus. A master can send messages without an external request, as long as it holds the bus access right (the token). Masters are also called active stations in the PROFIBUS standard.

DPM1, DPM2

There are two types of master devices: DP master class 1 (DPM1) and DP master class 2 (DPM2).

A DPM1 is a central controller which exchanges information with the decentralised stations (i.e. DP slaves) within a specified message cycle.

DPM2 devices are programmers, configuration devices or operator panels. They are used during commissioning, for configuration of the DP system, or for operation and monitoring purposes.

Slave devices

Slave devices are peripheral devices. Typical slave devices include input/output devices, valves, drives, and measuring transmitters. They do not have bus access rights and they can only acknowledge received messages or send messages to the master when requested to do so. Slaves are also called passive stations.

The C200HW-PRT21 is a PROFIBUS-DP slave device.

1-4 PROFIBUS-DP characteristics

1-4-1 Bus Access Protocol

Layer 2 The bus access protocol is implemented by layer 2. This protocol also includes data security and the handling of the transmission protocols and messages.

Medium Access Control The Medium Access Control (MAC) specifies the procedures which determine when a station is permitted to transmit data. A token passing procedure is used to handle the bus access between master devices, and a polling procedure is used to handle the communication between a master device and its assigned slave device(s).

Token passing The token passing procedure guarantees that the bus access right (the token) is assigned to each master within a precisely defined time frame. The token message, a special message for passing access rights from one master to the next master, must be passed around the logical token ring - once to each master - within a specified target rotation time.

Polling procedure The polling or master-slave procedure permits the master, which currently owns the token, to access its assigned slaves. The picture below shows a possible configuration.

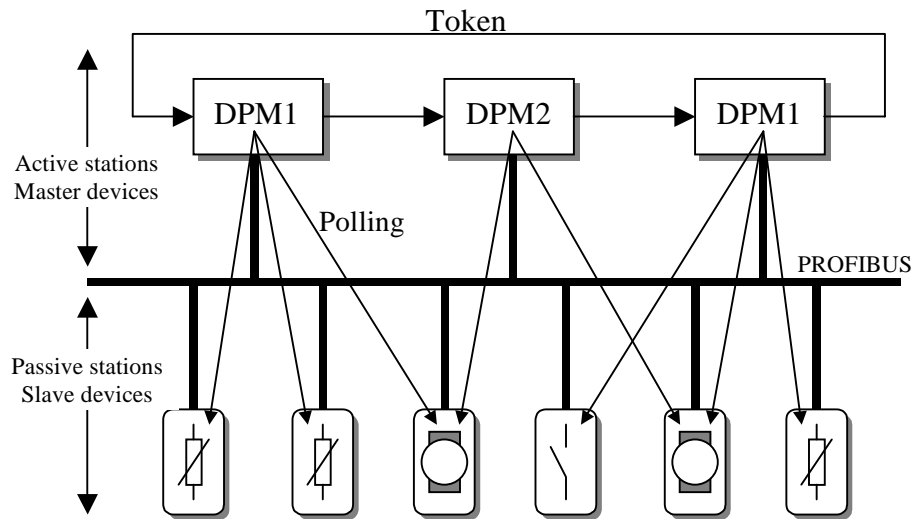

Figure 2. Token passing and Slave polling mechanisms

The configuration shows three active stations (masters) and six passive stations (slaves).

The three masters form a logical token ring. When an active station receives the token message, it can perform its master role for a certain period of time. During this time it can communicate with all assigned slave stations in a master-slave communication relationship, and a DPM2 master can take the initiative to communicate with DPM1 master stations in a master-master communication relationship.

Multi-peer communication

In addition to logical peer-to-peer data transmission, PROFIBUS-DP provides multi-peer communication (broadcast and multicast).

Broadcast communication: an active station sends an unacknowledged message to all other stations (masters and slaves).

Multicast communication: an active station sends an unacknowledged message to a predetermined group of stations (masters and slaves).

1-4-2 Data throughput

Transmission time

At 12 Mbit/s, PROFIBUS-DP requires only about 1 ms for the transmission of 512 bits of input data and 512 bits of output data distributed over 32 stations. The figure below shows the typical PROFIBUS-DP transmission time depending on the number of stations and the transmission speed. The data throughput will decrease when more than one master is used.

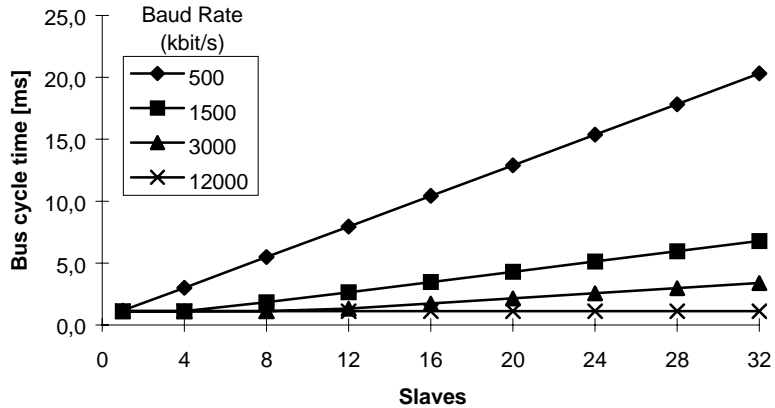

Figure 3. Bus cycle time vs. number of slaves

Conditions: Each slave has 2 bytes of input data and 2 bytes of output data.

1-4-3 Diagnostics functions

Extensive diagnostics

The extensive diagnostic functions of PROFIBUS-DP enable fast location of faults. The diagnostic messages are transmitted over the bus and collected at the master. These messages are divided into three levels:

Device related diagnostics

- Device related diagnostics
These messages concern the general operational status of the whole device (e.g. overtemperature or low voltage).

Module related diagnostics

- Module related diagnostics
These messages indicate that a fault is present in a specific I/O range (e.g. an 8-bit output module) of a station.

Channel related diagnostics

- Channel related diagnostics
These messages indicate an error at an individual input or output (e.g. short circuit on output 5).

1-4-4 Protection mechanisms

Time monitoring

PROFIBUS-DP provides effective protection functions against parameterisation errors or failure of the transmission equipment. Time monitoring is provided at the DP master and at the DP slaves. The monitoring interval is specified during the configuration.

- At the master**
- Protection mechanism at the master.
The DPM1 master monitors data transmission of its active slaves with the Data_Control_Timer. A separate control timer is used for each slave. This timer expires when correct data transmission does not occur within the monitoring interval.
If the master's Auto_Clear mode is enabled, the DPM1 exits the 'Operate' state, switches the outputs of all assigned slaves to fail-safe status, and changes to its 'Clear' state (see also section 1-4-5).
- At the slave**
- Protection mechanisms at the slave.
The slave uses the watchdog control to detect failures of the master or the transmission line. If no data communication with the master occurs within the watchdog control interval, the slave automatically switches its outputs to the fail-safe status. This mechanism can be enabled or disabled for each individual slave.
Also, access protection is available for the inputs and outputs of the DP slaves operating in multi-master systems. This ensures that direct access can only be performed by the authorised master. For other masters, the slaves offer an image of their inputs and outputs, which can be read by any master, even without access rights.

1-4-5 Network states

PROFIBUS-DP distinguishes four different network states.

- Off-line**
- Off-line
Communication between all DP participants is stopped.
- Stop**
- Stop
Communication between DPM1 and DP slaves is stopped. Only communication between DPM1 and DPM2 is possible.
- Clear**
- Clear
DPM1 master attempts to set parameters, check the configuration, and subsequently perform data exchange with its associated DP-slaves. The data exchange comprises reading the inputs of the DP-slaves and writing zero's to the outputs of the DP-slaves.
- Operate**
- Operate
DPM1 master exchanges data with its assigned slaves, inputs are read and outputs are written. Beside this, the DPM1 cyclically sends its local status to all assigned DP slaves (with a multicast message) at a configurable time interval.
- Auto_Clear**
- When an error occurs during the data transfer phase of the DPM1, the 'Auto_Clear' configuration setting determines the subsequent actions. If this parameter is set to false, the DPM1 remains in the 'Operate' state. If set to true, the DPM1 switches the outputs of all assigned DP slaves to the fail-safe state and the network state changes to the 'Clear' state.

1-5 Device Data Base files

DDB-file, GSD-file

To achieve straightforward configuration of a PROFIBUS-DP network, the characteristic features of a device are specified in a file. This file is called a DDB-file (Device Data Base file) or a GSD-file (Gerätetammdaten file). The GSD files are prepared individually by the vendor for each type of device, according to a fixed format. Some parameters are mandatory, some have a default value and some are optional.

The device data base file is divided into three parts:

General section

- General specifications

This section contains the vendor name, the device name, hardware- and software release versions, station type and identification number, protocol specification and supported baud rates.

DP-master section

- DP master-related specifications

This section contains all parameters which only apply to DP master devices (e.g. maximum memory size for the master parameter set, maximum number of entries in the list of active stations, or the maximum number of slaves the master can handle).

DP-slave section

- DP slave-related specifications

This section contains all specification related to slaves (e.g. minimum time between two slave poll cycles, specification of the inputs and outputs, and consistency of the I/O data).

Configurator

The device data base file of each device is loaded in the configurator and downloaded to the master device. Refer to the Operation Manual of the PROFIBUS-DP Master Unit for usage of the GSD file in the master's configuration software.

GSD files are usually supplied with each unit. Alternatively, GSD files can be downloaded from the Internet, either from the manufacturer's site, or from the GSD library of the PROFIBUS Nutzerorganisation at <http://www.profibus.com>.

1-6 Profiles

Exchanging devices

To enable the exchange of devices from different vendors, the user data has to have the same format. The PROFIBUS-DP protocol does not define the format of user data, it is only responsible for the transmission of this data.

The format of user data may be defined in so called profiles. Profiles can reduce engineering costs since the meaning of application-related parameters is specified precisely. Profiles have been defined for specific areas like drive technology, encoders, and for sensors / actuators.

SECTION 2

Specifications and Performance

This section describes the overall specifications and the communication performance of the Unit.

2-1	Overall Specifications	10
2-2	Dimensions	11
2-3	Performance	12

2-1 Overall Specifications

Table 1. Overall Specifications

Model code		C200HW-PRT21		
Installation	Host PLC system	C200HS, C200HE, C200HG, C200HX, CS1		
	Maximum number of Units per PLC system	C200HS, C200HE	10	
		C200HG-CPU3□-E/CPU4□-E C200HX-CPU3□-E/CPU4□-E		
		All others	16	
	Unit mounting position	CPU Rack or Expansion I/O Rack Unit cannot be mounted to SYSMAC BUS Slave Racks. Unit cannot be used on a C200H-CPU□□ PLC system.		
Current consumption	250 mA (maximum) at 5 V DC from PLC power supply			
Weight	180 g (typical)			
Environment	Storage temperature	-20 to +75°C		
	Operating temperature	0 to +55°C		
	Operating humidity	10 to 90% (non-condensing)		
	Conformance to EMC- and environmental standards	EN50081-2 EN61131-2		
User interface	Switch Settings	Special I/O Unit number (0-F) by rotary switch PROFIBUS-DP node address (000-125) by 3 rotary switches		
	LED indicators	Unit status: RUN (green LED), ERR (red LED) Network status: COMM (green LED), BF (red LED)		
PLC interface	No. of IR words	PLC ↔ Unit: 3 words (1 word of control data + 2 words slave input data) Unit ↔ PLC: 5 words (3 words of Unit status + 2 words slave output data)		
	No. of DM settings	8 words of Unit setup information		
	Amount of I/O data per Unit	Default [DM settings all 0000]	all PLC's: 2 words in + 2 words out	
		With user defined DM settings	C200HS: up to 80 words in + out all others: up to 100 words in + 100 words out	
PROFIBUS interface	Bus connector	9-pin female sub-D connector (RS-485 PROFIBUS connector)		
	Bus address	0 to 125, Remote setting not supported		
	Baud rate (auto-detect)	9.6k, 19.2k, 45.45k, 93.75k, 187.5k, 500k, 1.5M, 3M, 6M, 12M bit/s		
	Supported functions (as responder)	to DPM1 + DPM2 masters	Data_Exchange Set_Prm Chk_Cfg Slave_Diag Global_Control (SYNC/FREEZE/CLEAR)	
		to DPM2 master only	RD_Inp RD_Outp Get_Cfg	
	Station type	Modular station, max. 32 modules Configurable with In-, Out-, and I/O-modules of 1, 2, 4, 8, and 16 words Total of 0~100 words in + 0~100 words out, with consistency over the full length		
	GSD file	OC_04AC.GSD		

2-2 Dimensions

Dimensions

The following figure shows the dimensions of the Unit. Refer to the PLC's Installation Guide for the dimensions of the Unit when it is mounted to the Backplane of the host PLC. (All dimensions are in mm.)

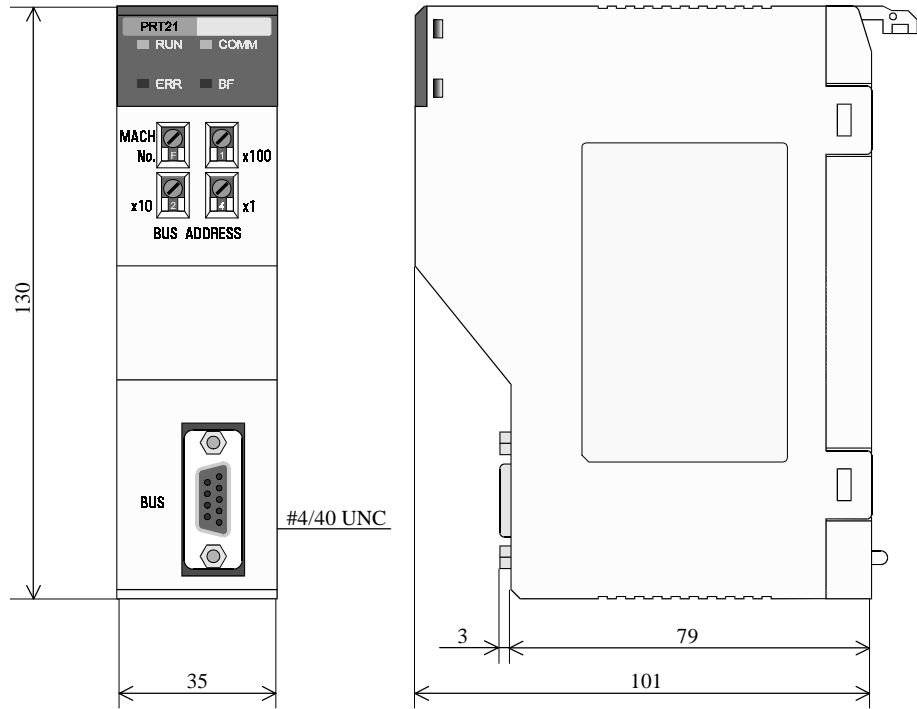

Figure 4. Dimensions

2-3 Performance

The C200HW-PRT21's task is to exchange predetermined amounts of data between the host PLC system and a PROFIBUS-DP master unit. The C200HW-PRT21 is not able to initiate data exchanges with either side. Its performance in terms of data transfer rate is therefore mainly governed by two factors external to the Unit: the PROFIBUS-DP cycle time and the host PLC's cycle time.

The PLC cycle and the PROFIBUS-DP cycle will generally be:

- independent,
- of unequal length,
- more or less variable,

Asynchronous

and therefore fundamentally asynchronous.

In case the PROFIBUS-DP cycle time is longer than the host PLC cycle time, it may occur that slave input data, sent by the Unit's host PLC only during a single PLC cycle, cannot be read in time by the PROFIBUS master.

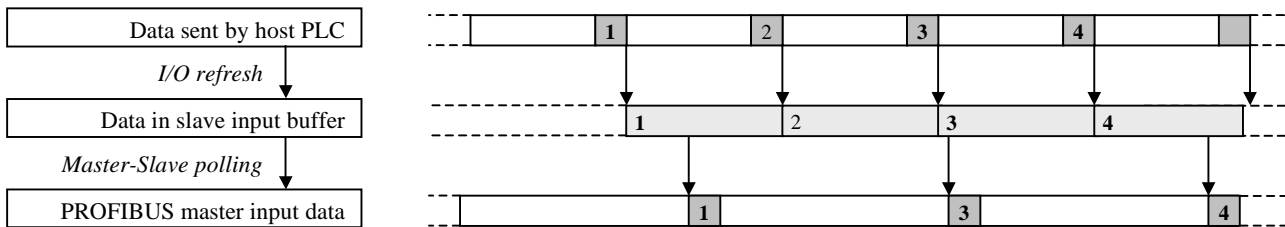

Figure 5. PROFIBUS cycle longer than host PLC cycle

In case the PROFIBUS-DP cycle time is shorter than the host PLC cycle time, it may occur that slave output data, sent by the PROFIBUS master only during a single fieldbus cycle, cannot be read in time by the Unit's host PLC.

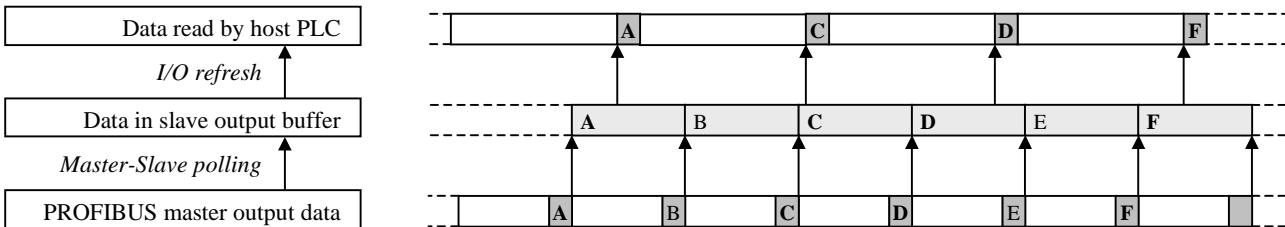

Figure 6. PROFIBUS cycle shorter than host PLC cycle

If it necessary that each different set of transmitted data is acknowledged by the receiving side, the user will have to implement a verification mechanism in the PLC programs on both the master and the slave PLC.

An example is to reserve one byte/word in the master's data block for a transmission counter, which is copied back by the slave in its reply. The master may only transmit the next data if the received counter value equals the sent value, indicating that the previous data was received by the slave.

Consistency

The C200HW-PRT21 guarantees consistency over the full length of the PROFIBUS data message, i.e. all I/O data in one PROFIBUS message is transferred to the host PLC in one I/O refresh, and vice versa.

PROFIBUS-DP cycle time	<p>The overall PROFIBUS-DP communication cycle time will depend on the number and types of PROFIBUS-DP master(s) and other slaves connected to the network, and the overall bus parameters defined in the configuration of the master unit(s).</p> <p>The time required to exchange I/O data between the C200HW-PRT21 and its master will depend on the number of input and output words defined in the master's configuration, the selected baud rate, and on the performance of the master unit itself.</p> <p>The minimum time interval between subsequent I/O data exchanges with the C200HW-PRT21 (minimum slave interval) is 0.5 ms as defined in the Unit's GSD file.</p>
PLC cycle time	<p>The host PLC's cycle time mainly depends on the size of the PLC program and the I/O refresh times of all I/O Units on its backplanes.</p> <p>The size of the PLC program is application specific. Besides optimising the PLC program, the program execution time can only be decreased by using a faster CPU Unit.</p>
I/O Refresh Time	<p>The total I/O refresh time depends on the types of Units that are mounted on the Backplane(s). Not all Units refresh the same amount of data.</p> <p>The I/O refresh time of the C200HW-PRT21 depends on the number of I/O data words that have been mapped, and on the host CPU type.</p>
Calculation	<p>Using the default mapping mode (2 words I/O, using the Special I/O unit's IR area), the I/O refresh times of the C200HW-PRT21 are:</p> <ul style="list-style-type: none"> on C200HS: 1.2 ms on C200HE, -HG, -HX and CS1: 0.9 ms <p>With user defined I/O mapping, the I/O refresh time can be estimated with the following formulas:</p> <p>C200HS:</p> $t_{\text{IORF}} = 0.9 + 0.5 \times n_a + 0.07 \times n_w \text{ [ms]}$ <p>C200HE, C200HG, C200HX, CS1:</p> $t_{\text{IORF}} = 0.8 + 0.5 \times n_a + 0.02 \times n_w \text{ [ms]}$ <p>where n_a = number of data areas (0~2) n_w = number of input + output words (0 ~ 200, except C200HS: 0 ~ 80)</p> <p>Refer to the Operation Manual of the CPU for more detailed calculations of the PLC cycle time.</p>

SECTION 3

Installation

This section describes the installation of the C200HW-PRT21.

3-1	Physical layout of the Unit	16
3-1-1	LEDs	16
3-1-2	Rotary Switches	17
3-1-3	BUS Connector	18
3-2	Mounting the C200HW-PRT21	19
3-3	Setting up a network	19
3-3-1	Fieldbus cabling	19
3-3-2	Configuring PROFIBUS-DP systems	22

3-1 Physical layout of the Unit

The figure below shows the front and side views of the C200HW-PRT21.

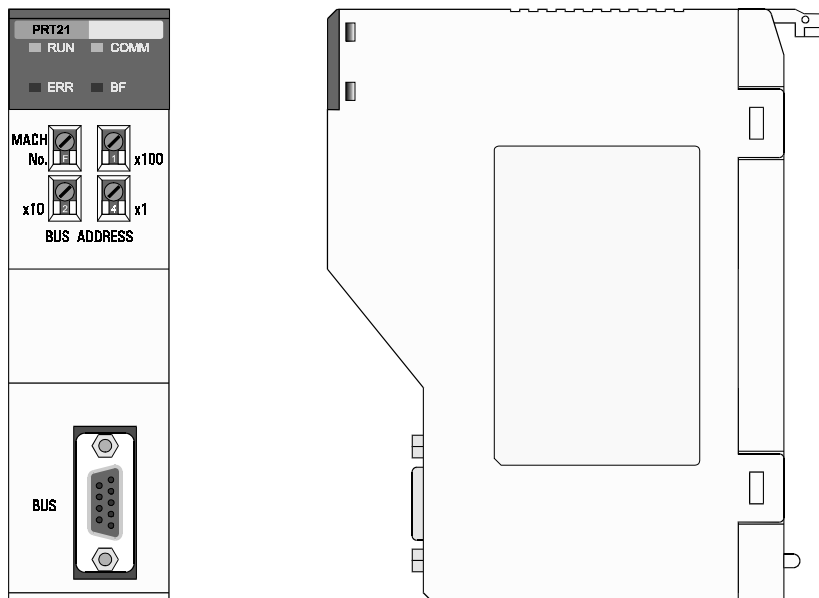

Figure 7. Front view and side view of the C200HW-PRT21

The front view shows the indicator LEDs, the rotary switches, and the 9-pin female sub-D PROFIBUS-DP connector.

3-1-1 LEDs

The C200HW-PRT21 has 4 indicator LEDs.

The two LEDs on the left side (RUN and ERR) give a status indication of the Unit in general.

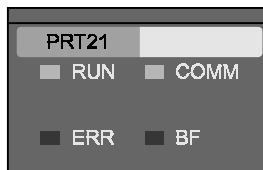

The two LEDs on the right side (COMM and BF) are related to the status of the PROFIBUS-DP network.

During normal operation, the RUN and COMM LEDs (green) should be lit, while the ERR and BF LEDs (red) should be OFF.

Refer to Section 4-4 for a detailed description of the LED functions.

3-1-2 Rotary Switches

The C200HW-PRT21 has 4 rotary switches to:

- set its Special I/O Unit number or Machine No. (0-F)
- set the PROFIBUS-DP node address (000-125)

Note Always turn off the power to the PLC before changing a rotary switch setting. The Unit only reads the settings during the initialisation after power-on.

Use a small flat-blade screwdriver to turn the rotary switches; be careful not to damage the switches.

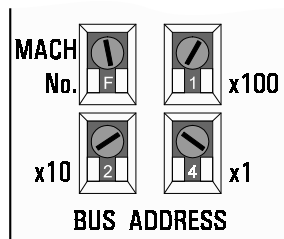

Figure 8. Rotary Switches

MACH No.

The MACH No. rotary switch (top left) is used to select the C200H Special I/O Unit number or so called “Machine No.”.

The Special I/O Unit number setting determines which words in the Internal Relay Area and Data Memory Area are allocated to the C200HW-PRT21.

The allowed setting range depends on the PLC CPU type used, as shown in the following table.

Table 2. Machine No. setting per CPU type

CPU Unit models	MACH No. range	Setting method
C200HS, C200HE, C200HG-CPU3□-E/CPU4□-E, C200HX-CPU3□-E/CPU4□-E	0 to 9	Single-digit hexadecimal
C200HG-CPU5□-E/CPU6□-E, C200HX-CPU5□-E/CPU6□-E/CPU8□-ZE CS1-series*	0 to F	

Any Unit number in the setting range is allowed as long as it has not been set on another Special I/O Unit connected to the PLC. If the same number is used for the C200HW-PRT21 and another Special I/O Unit, an I/O Unit Over error will occur in the PLC, and it will not be possible to start up the PROFIBUS-DP Slave communication.

* For details on CS1-series PLC compatibility, see Appendix A.

BUS ADDRESS

Three switches, marked **x100**, **x10** and **x1**, are used to set the PROFIBUS-DP node address of the Unit. Addresses in the range of 000 through 125 are valid. The example in Figure 8 shows address 124.

Note An invalid address setting, i.e. any value above 125, will be detected during power-on initialisation, and indicated to the host PLC (see IR n+3.07 in Section 4-3-2). No PROFIBUS-DP communication will take place if an incorrect address is set.

Some PROFIBUS-DP masters do not support all possible slave addresses.

3-1-3 BUS Connector

The fieldbus connector is a 9-pin female sub-D connector, as recommended in the PROFIBUS standard EN50170 Vol.2.

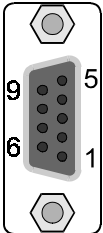

Pin No.	Signal	Description
1	Shield	Shield/functional ground
2	-	-
3	B-line	Data signal
4	RTS	Direction control signal for repeaters (TTL)
5	DGND	Data ground
6	VP	Supply voltage for terminator resistance (+5V)
7	-	-
8	A-line	Data signal
9	-	-

Figure 9. PROFIBUS Connector

Data Signal

The PROFIBUS User Group recommends the following colour coding for the data signal lines:

A-line = Green

B-line = Red

These data signal lines must be connected to the corresponding signal terminals or pins at the master unit and other stations (i.e. A to A, B to B).

For detailed PROFIBUS-DP cable requirements, see Section 3-3-1.

RTS

The signal RTS (TTL signal relative to DGND) is meant for the direction control of repeaters in case repeaters without self control capability are used.

VP, DGND

The signals VP and DGND are meant to power an externally mounted bus terminator (see Figure 10).

The powering of the 220 Ω termination resistor ensures a defined idle state potential on the data lines. To ensure proper functioning up to the highest baud rate, each bus segment has to be terminated at both ends of the cable.

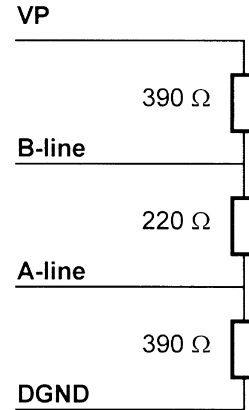

Figure 10. PROFIBUS Termination

3-2 Mounting the C200HW-PRT21

The C200HW-PRT21 PROFIBUS-DP Slave Unit can be mounted to the CPU Rack or Expansion I/O Rack of any CS1, C200HX, -HG, -HE, or -HS PLC. Refer to the PLC's Operation Manuals for details on mounting Units.

Limitations

There are some limitations on mounting the Unit.

- The current consumption of all Units mounted on one backplane should not exceed the maximum output of the power supply. The C200HW-PRT21 consumes up to 250 mA from the 5V supply. Verify the characteristics of all other Units on their respective Instruction Sheets.
- The C200HW-PRT21 is a Special I/O Unit. It can be mounted in any slot in the Backplane of a CPU Rack or Expansion I/O Rack as long as its Unit number is not the same as the Unit number of another Special I/O Unit within the system.
- The maximum number of Special I/O Units that can be mounted depends on the PLC CPU type.
- For details on CS1-series PLC compatibility, see Appendix A.

Table 3. Maximum number of Special I/O Units

CPU Unit models	Max. number of Special I/O Units
C200HS, C200HE, C200HG-CPU3□-E/CPU4□-E, C200HX-CPU3□-E/CPU4□-E	10
C200HG-CPU5□-E/CPU6□-E, C200HX-CPU5□-E/CPU6□-E/CPU8□-ZE CS1-series	16

3-3 Setting up a network

3-3-1 Fieldbus cabling

Bus structure

All PROFIBUS-DP devices are connected in a line structure. Each RS-485 bus segment may contain up to 32 stations (masters, slaves, repeaters). When more than 32 stations are required, repeaters must be used to link the individual bus segments. The bus must be terminated at the beginning and at the end of each segment.

Cable type

The standard EN50170 Vol.2 specifies to use shielded twisted pair cables with the following parameters (PROFIBUS line type A):

Table 4. PROFIBUS Cable parameters

Parameter	Value
Impedance	135 to 165 Ω (3 to 20 MHz)
Capacitance per unit length	< 30 pF/m
Loop resistance	< 110 Ω/km
Core diameter	> 0.64 mm
Core cross section	> 0.34 mm ² (22 AWG)

Maximum length

The maximum length of the cable depends on the transmission speed. The cable lengths specified in the table below are based on the above cable specifications.

Table 5. Maximum cable lengths

Baud rate (kbit/s)	Length/segment (m)
9.6, 19.2, 45.45, 93.75	1200
187.5	1000
500	400
1500	200
3000, 6000, 12000	100

Repeaters

The maximum communication distance as specified in Table 5 can be increased by the use of repeaters. The repeater must be included in the count of the number of stations on the segment. Even though repeaters do not have a node address, they represent an electrical load on the bus segment like any master or slave station.

If a repeater is located at the end of a bus segment, it should provide bus termination as well.

It is recommended to limit the number of repeaters in series between any two stations in the system to a maximum of three units, as shown in the following example (3 repeaters are encountered in communication between segment 6 and segments 1, 2 and 4).

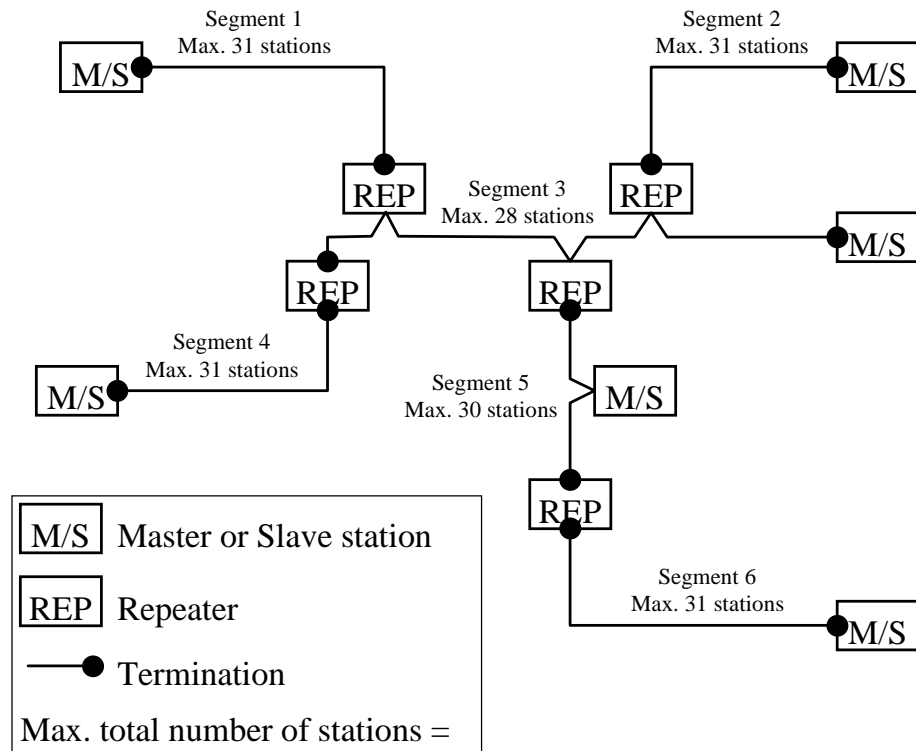
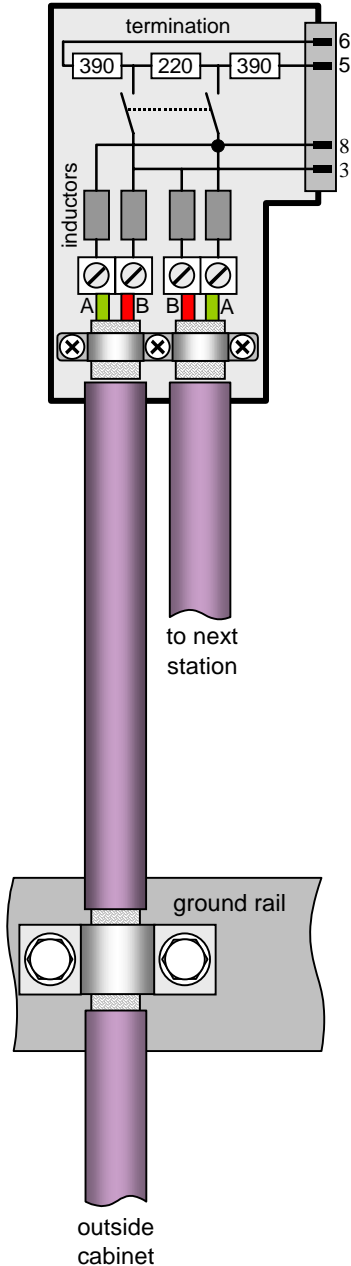

Figure 11. Example of a PROFIBUS system using repeaters

Stub lines

Stub lines (branches from the main line) should be avoided for data transmission speeds of more than 500 kbit/s. Except at end stations with termination, it is recommended to always use plug connectors that permit two data cables to be connected directly to the plug. This method allows the bus connector to be plugged and unplugged at all times without interrupting data communication between other stations.

Fieldbus connector



The connector plug to be used on the C200HW-PRT21 is a 9-pin male sub-D connector, preferably with a metal case, and a facility to connect the shield of the cable to the case. The cable should at least be connected to pin 3 (B-line) and pin 8 (A-line) of the connector.

At baud rates of 1.5 Mbit/s or higher, always use special PROFIBUS-DP connectors with built-in series inductances, to ensure that cable reflections caused by the capacitive the load of each unit are minimised.

Connectors with built-in inductors and termination resistors, as shown here schematically, are available from various manufacturers.

To ensure electro-magnetic compatibility (EMC), the shield of the cable should be connected to the metal case of the connector. If this is impossible, use pin 1.

If the Unit is installed within a control cabinet, the cable shield of the bus cable should be electrically connected to a grounding rail as close as possible to the cable lead-through using a shield grounding clamp or similar. The cable shield should continue within the cabinet to the fieldbus device.

Ensure that the PLC and the control cabinet in which the device is mounted have the same ground potential by providing a large-area metallic contact to ground (use e.g. galvanised steel to ensure a good connection). Grounding rails should not be attached to painted surfaces.

You may find further information about

- Commissioning of PROFIBUS equipment
- Testing the PROFIBUS cable and bus connectors
- Determining the loop resistance
- Testing for correct bus termination
- Determining the segment length and cable route
- Other test methods
- Example of an equipment report

in the PROFIBUS guideline "Installation Guideline for PROFIBUS-DP/FMS" (PNO Order No- 2.112), which is available at every regional PROFIBUS user organisation.

Figure 12. Recommended PROFIBUS-DP connector type and grounding method

3-3-2 Configuring PROFIBUS-DP systems

After making the physical connections of the network, the PROFIBUS-DP system needs to be configured. For each master and its assigned slaves, a configuration has to be defined using a dedicated configuration program.

Configurator

The configurator provides the master with information about:

- The slaves that are connected to the master.
- The assignment of slaves to groups for broadcast/multicast messages.
- The mapping of the slaves into the memory of the master.
- The bus parameters (e.g. baud rate, target rotation time etc.).

C200HW-PRM21

For more details about the configurator for the C200HW-PRM21 Master Unit, refer to OMRON Catalog No. W349-E1.

GSD file

To configure a master unit to communicate with the C200HW-PRT21, the Unit's device database file OC_04AC.GSD is required. Based on the contents of this file, the configuration program for the master unit will allow the user to specify the amount of input- and output data to be exchanged. The sizes of the in- and the output block can both be set in 1-word increments from 0 to 100 words.

Modular slave

The C200HW-PRT21 is characterised as a modular slave. The following types of data exchange modules are predefined:

DEFAULT MODE	2 words input + 2 words output; to be selected if the Unit is installed without user-defined data mapping (see section 4-2-1).
IN	modules of 1, 2, 4, 8, and 16 words
OUT	modules of 1, 2, 4, 8, and 16 words
IN/OUT	modules of 1+1, 2+2, 4+4, 8+8, and 16+16 words

By concatenating up to 32 modules, any desired size of input and output block can be created (multiple selections of any module type are allowed).

The sequence in which the modules are entered is irrelevant. Only the resulting total lengths of the input and output areas are of significance.

Check configuration

Upon startup of the PROFIBUS-DP communication, the master unit will send a Chk_Cfg message so that the slave can verify that the master's expected I/O configuration for the slave is correct. The C200HW-PRT21 Slave Unit will allow I/O data communication to be started only if the total number of input and output words match the area sizes as defined by its DM settings (see Section 0).

Example

The example below shows a slave configuration screen. The C200HW-PRT21 is configured as a slave with $(16+16+4=)$ 36 words input data and $(16+16+8=)$ 40 words output data. The terms input and output are to be interpreted as seen from the PROFIBUS-DP master unit.

The screenshot shows the 'DP Slave configuration data' dialog box. It contains several input fields and two tables. Callouts on the left side explain the components:

- I/O data limits, defined in GSD file:** Points to the top section with fields for 'Maximum number of modules' (32), 'Length of the input and output data' (152 Byte), 'Max. length of input and output data' (400 Byte), 'Maximum length of input data' (200 Byte), 'Length of input data' (72 Byte), 'Maximum length of output data' (200 Byte), and 'Length of output data' (80 Byte). A 'Watchdog control' checkbox is also present.
- List of available module types, defined in GSD file:** Points to the table listing module types such as '1 word In', '2 words In', '4 words In', '8 words In', '16 words In', '1 word Out', '2 words Out', and '4 words Out'.
- List of modules, selected by user:** Points to the table showing the selected configuration with columns for 'Idx', 'Module name', 'Type', and 'BYTE OFFSET'.
- Total I/O sizes, calculated by configurator:** Points to the bottom section of the dialog box.

Module name	Inputs	Outputs	In/Output	Manufacturer specific data
DEFAULT MODE			4 Byte	
1 word In	2 Byte			
2 words In	4 Byte			
4 words In	8 Byte			
8 words In	16 Byte			
16 words In	32 Byte			
1 word Out		2 Byte		
2 words Out		4 Byte		
4 words Out		8 Byte		

Idx	Module name	Type	BYTE OFFSET	Type	BYTE OFFSET
1	16 words In/Out	IW	0	QW	0
1	16 words In/Out	IW	32	QW	32
1	4 words In	IW	64		
1	8 words Out			QW	64

Figure 13. C200HW-PRT21 Configuration example

SECTION 4

User Interface

This section describes the interface with the user via the PLC system. This includes Unit settings to configure the Unit plus the control and status areas.

4-1	Input and Output Data	26
4-2	Unit Settings	27
4-2-1	I/O Data Mapping	28
4-2-2	I/O Data Format	30
4-3	Control and status area	31
4-3-1	PLC → Unit	32
4-3-2	Unit → PLC	33
4-4	LEDs	38

4-1 Input and Output Data

The C200HW-PRT21 forms a link between two bus systems: the host PLC's I/O bus on one side, and PROFIBUS-DP on the other. The Unit can be considered as a slave to both systems: the I/O bus communication is controlled by the CPU Unit of the host PLC, the PROFIBUS-DP communication is controlled by a PROFIBUS-DP master.

Definitions

Being a slave to two systems may cause confusion as to which data should be considered 'input data' and which is 'output data'. In this manual all I/O data communication is defined from the point of view of the PROFIBUS-DP system:

Slave INPUT Data

Slave INPUT Data is process data which the C200HW-PRT21 reads from the assigned areas on demand of the host PLC. The C200HW-PRT21 sends this data to the PROFIBUS-DP master unit.

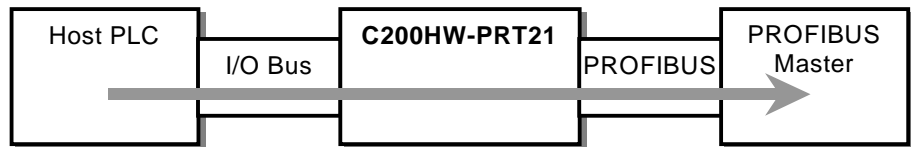

Figure 14. Slave INPUT data direction

Slave OUTPUT Data

Slave OUTPUT Data is process data which the C200HW-PRT21 receives from the PROFIBUS-DP master unit. The C200HW-PRT21 writes this data to the assigned areas on demand of the host PLC.

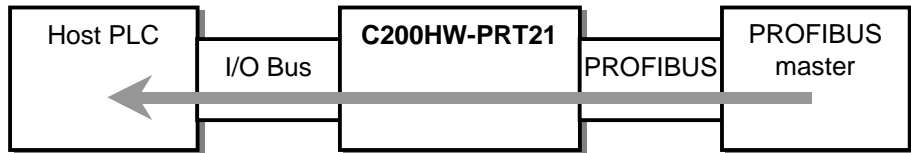

Figure 15. Slave OUTPUT data direction

4-2 Unit Settings

As a Special I/O Unit, the C200HW-PRT21 can be configured with settings made in a dedicated DM area. The Unit settings determine the amount and format of I/O data to be exchanged between the host PLC and the C200HW-PRT21. The assigned DM area depends on the Unit number setting:

Table 6. Unit Setting areas

MACH No.	DM area*	
0	DM1000 to DM1007	All C200H PLC models
1	DM1100 to DM1107	
2	DM1200 to DM1207	
3	DM1300 to DM1307	
4	DM1400 to DM1407	
5	DM1500 to DM1507	
6	DM1600 to DM1607	
7	DM1700 to DM1707	
8	DM1800 to DM1807	
9	DM1900 to DM1909	
A	DM2000 to DM2007	All C200H PLC models except: C200HS, C200HE, C200HG-CPU3□-E/CPU4□-E, C200HX-CPU3□-E/CPU4□-E
B	DM2100 to DM2107	
C	DM2200 to DM2207	
D	DM2300 to DM2307	
E	DM2400 to DM2407	
F	DM2500 to DM2507	

* Alternatively starting at DM7000 to DM8500, selected by PLC setup of C200H: DM6602 (0000 (see Operation Manual of CPU Unit).

* For CS1 allocations, see Appendix A.

The first word in the DM area allocated to the Unit will be indicated by **DM m**, the last word by **DM m+7**.

Table 7. Overview of Unit settings

DM Word	Function
m	Slave input mapping mode
m+1	Start address of slave input data area
m+2	Size of slave input data area
m+3	Slave output mapping mode
m+4	Start address of slave output data area
m+5	Size of slave output data area
m+6	Data format of slave inputs
m+7	Data format of slave outputs

The values entered in the Unit settings area are only transferred to the Unit during initialisation, i.e. at power on and at Special I/O Unit restart.

Default Mode

The Unit is said to operate in Default Mode when the values of all Unit settings are zero. In Default Mode, I/O data exchange is limited to 2 words in + 2 words out, from/to predefined locations in the host PLC (See Section 4-3).

4-2-1 I/O Data Mapping

Data flow

The figure below shows the flow of remote I/O data in the PLC system.

It is possible to map the PROFIBUS-DP I/O data to the DM, LR, IR and HR areas of the PLC memory. The input and output areas can be assigned independently.

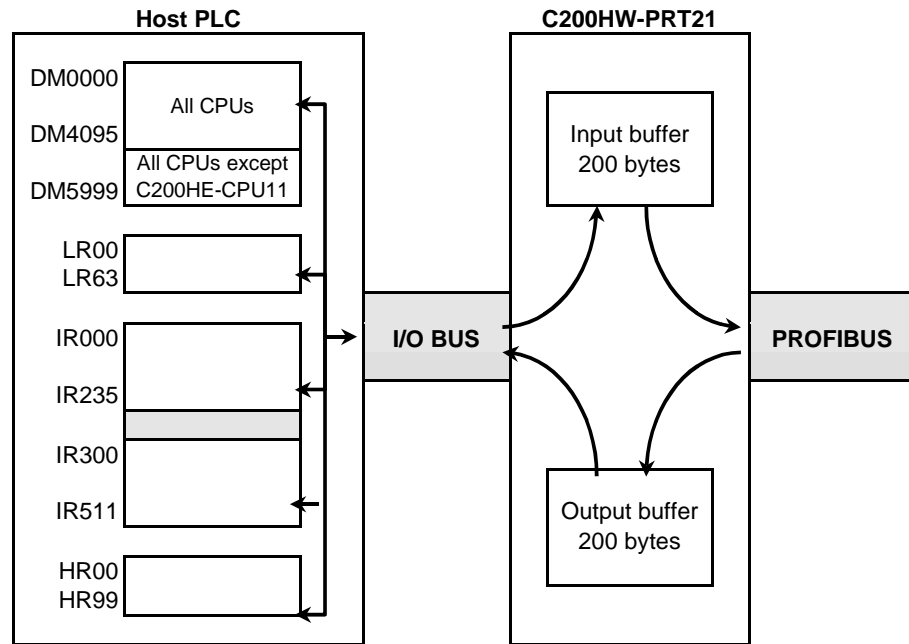

Figure 16. Process data flow

Slave input data is transferred via the I/O bus on the PLC Backplane to the input buffer of the Unit. Each PROFIBUS-DP cycle this data is transmitted to the master over PROFIBUS.

Slave output data received from PROFIBUS is first stored in the output buffer of the Unit. During an I/O refresh, this data is transferred to the memory of the host PLC via the I/O Bus.

I/O refresh

By default, I/O refreshes are executed at the end of each PLC program cycle, but they can also be triggered by the IORF instruction. See the applicable PLC CPU Operation Manual for more details.

Maximum I/O data

For C200HS, the maximum amount of mapped I/O data is 80 words input + output. For all other supported PLC models, the maximum is 100 words input + 100 words output.

Table 8 lists the DM words for configuration of the I/O data mapping, with the possible values and their meaning.

Setting values in BCD

Except for the definition of the start address in the PLC CPU, all values are in BCD. To distinguish between start addresses in different PLC memory areas, the first digit of the 'start address' indicates the PLC memory area, and the following three digits indicate the address in the area in BCD format.

Table 8. Configuration of I/O data mapping

DM word	Value	Meaning
m	Slave input mapping mode	
	≠ 0001	Default input mapping, from IR n+1, IR n+2 only Any settings in DM m+1, m+2 are ignored
	= 0001	User defined input mapping by DM m+1, DM m+2
m+1	Start address of slave input data area (valid if DM m = 0001)	
	0000 ~ 5999	DM0000 ~ DM5999 (C200HE: 0000 ~ 4095)
	A000 ~ A235	IR000 ~ IR235
	A300 ~ A511	IR300 ~ IR511
	B000 ~ B099	HR00 ~ HR99
	C000 ~ C063	LR00 ~ LR63
	other	Setting error *1, no slave input data is transferred
m+2	Size of slave input data area (valid if DM m = 0001)	
	0000 ~ 0100	0 ~ 100 words to be transferred from PLC to slave input buffer *2
	other	Setting error *1, no slave input data is transferred
m+3	Slave output mapping mode	
	≠ 0001	Default output mapping, to IR n+6, IR n+7 only Any settings in DM m+4, m+5 are ignored
	= 0001	User defined output mapping by DM m+4, DM m+5
m+4	Start address of slave output data area (valid if DM m+3 = 0001)	
	0000 ~ 5999	DM0000 ~ DM5999 (C200HE: 0000 ~ 4095)
	A000 ~ A235	IR000 ~ IR235
	A300 ~ A511	IR300 ~ IR511
	B000 ~ B099	HR00 ~ HR99
	C000 ~ C063	LR00 ~ LR63
	other	Setting error *1, no slave output data is transferred
m+5	Size of slave output data area (valid if DM m+3 = 0001)	
	0000 ~ 0100	0 ~ 100 words to be transferred from slave output buffer to PLC *2
	other	Setting error *1, no slave output data is transferred

*1 These setting errors are indicated in IR n+3 (see section 4-3) and the ERR LED will be flashing to indicate a non-fatal error. The PROFIBUS-DP master will indicate a configuration error at the slave if a non-zero data length is configured at the master.

*2 If the specified number of words would make the area exceed the boundaries of the PLC's DM, LR, IR or HR areas, no data will not be transferred to/from that area. The input- or output data length will be set to 0. Error indication is the same as in *1.

**Caution**

The Unit cannot check the validity of the contents of any PLC data area, from which slave input data is to be transferred. Any data present in the area will be transferred to the input buffer of the Unit.

**Caution**

The Unit does not check if the selected slave output area in the host PLC is in use by other Units, e.g. other fieldbus Master or Slave Units mounted in the same system. If so, this Unit's data may overwrite another Unit's data, or vice versa.

4-2-2 I/O Data Format

The C200HW-PRT21 allows the user to select between two methods to map the word-oriented PLC data to the essentially byte-oriented PROFIBUS-DP messages. The default method is Motorola format (Big-Endian), which allows easy data exchange with other OMRON PROFIBUS-DP devices. For communication with other manufacturers' devices, in some cases it may be more convenient to select Intel format (Little-Endian).

Motorola (Big-Endian)

By default, the most significant byte of a PLC data word will be mapped to an even byte in the PROFIBUS-DP message, the least significant byte is mapped to an odd byte, e.g.

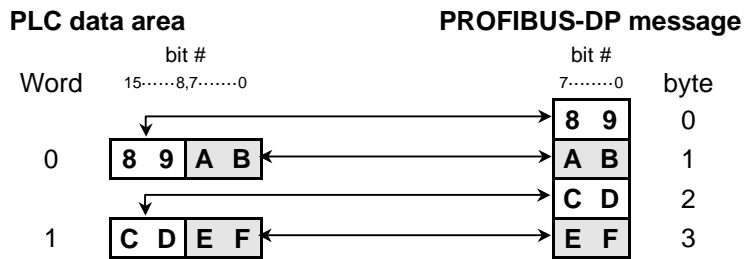

Figure 17. MOTOROLA mode

Intel (Little-Endian)

Alternatively, selecting Intel format will result in:

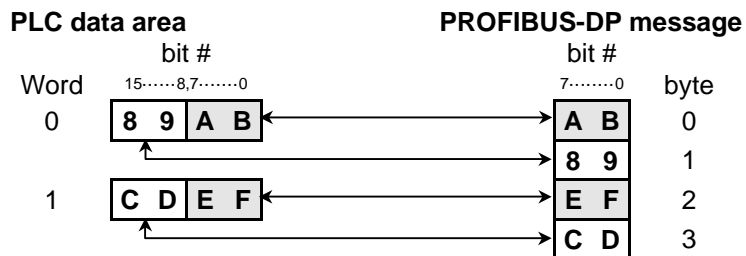

Figure 18. INTEL mode

DM words m+6 and m+7 allow an independent selection of the data format for slave inputs and slave outputs:

Table 9. Configuration of I/O data format

DM word	Value	Meaning
m+6	Data format of slave inputs	
	≠ 0001	Motorola mode (PLC high byte mapped to 1 st PROFIBUS-DP byte)
	= 0001	Intel mode (PLC low byte mapped to 1 st PROFIBUS-DP byte)
m+7	Data format of slave outputs	
	≠ 0001	Motorola mode (1 st PROFIBUS-DP byte mapped to PLC high byte)
	= 0001	Intel mode (1 st PROFIBUS-DP byte mapped to PLC low byte)

4-3 Control and status area

After initialisation of the Unit (RUN LED is ON), the control- and status words are exchanged between the host PLC and the Unit during each I/O refresh. The mapping of the control- and status words depends on the Machine number set by the MACH No. rotary switch at the front of the Unit.

Table 10. Control and Status areas

MACH No.	IR area*	
0	IR100 to IR107	All C200H PLC models
1	IR110 to IR117	
2	IR120 to IR127	
3	IR130 to IR137	
4	IR140 to IR147	
5	IR150 to IR157	
6	IR160 to IR167	
7	IR170 to IR177	
8	IR180 to IR187	
9	IR190 to IR197	
A	IR400 to IR407	All C200H PLC models except: C200HS, C200HE, C200HG-CPU3□-E/CPU4□-E, C200HX-CPU3□-E/CPU4□-E
B	IR410 to IR417	
C	IR420 to IR427	
D	IR430 to IR437	
E	IR440 to IR447	
F	IR450 to IR457	

* For CS1 allocations, see Appendix A.

The first word in the IR area allocated to the Unit will be indicated by **IR n**, the last word by **IR n+7**.

Table 11. Overview of Control and Status words

IR Word	Function	Direction
n	Unit Control Bits	PLC → Unit
n+1	Slave Input word 1	
n+2	Slave Input word 2	
n+3	Unit Status Flags	Unit → PLC
n+4	Slave Parameter data (master + groups)	
n+5	Slave Parameter data (watchdog factors)	
n+6	Slave Output word 1	
n+7	Slave Output word 2	

The first three words are transferred from the host PLC to the Unit. In Default Mode, these contain the 2 slave input words.

The next five words are transferred from the Unit to the host PLC. In Default Mode, these contain the 2 slave output words.

4-3-1 PLC → Unit

The host PLC always transfers 3 words of data from its IR area to the C200HW-PRT21. In Default Mode, this includes 2 words of slave input data.

Any bits of these words which are not assigned to a specific function can freely be used as work bits. These bits will be ignored by the C200HW-PRT21.

Unit Control Bits

IR n contains a control bit which influences the operation status of the Unit.

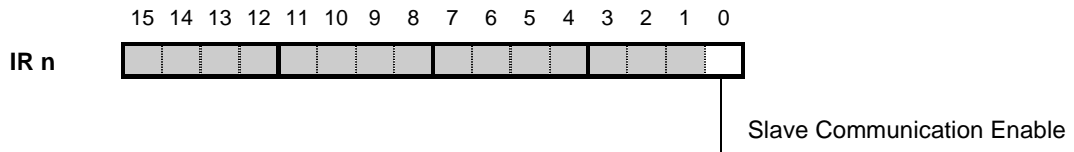

IR n.00 Slave communication enable

0: PROFIBUS-DP communication is disabled. The Slave Unit will go offline, and not respond to any master requests.

1: Normal operation; PROFIBUS-DP communication is enabled. To enable data exchange, this bit should be set ON by the PLC program, or can be forced ON when the PLC is in PROGRAM mode.

This bit allows the master to detect if the Slave Unit's host PLC is in normal operation. In case of fatal PLC errors, IR n.00 will revert to 0, and all PROFIBUS-DP data communication will be suspended.

Slave Input Data

IR n+1 and IR n+2 may be used to send data from the Unit's host to the PROFIBUS-DP master.

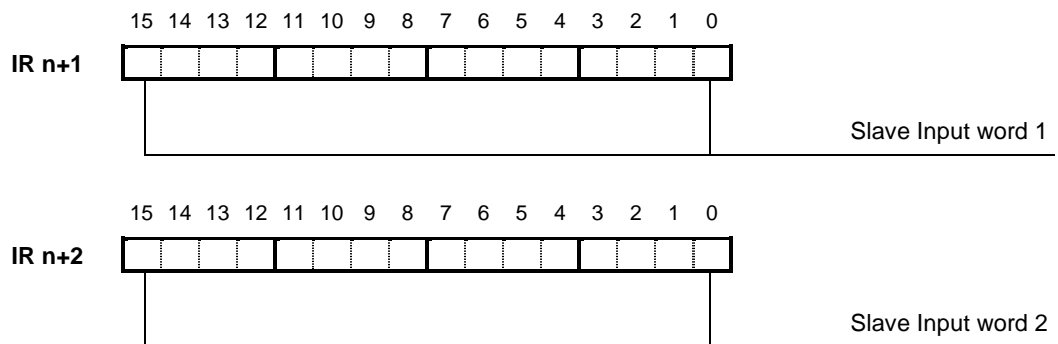

IR n+1, IR n+2

Slave Input words

In case DM m is set to a value not equal to 0001 (i.e. default input data mapping), only these two words are used to transfer data from the host PLC to the C200HW-PRT21, and subsequently send it as slave input data to the PROFIBUS-DP master unit.

If DM m is set to 0001 (i.e. user defined input mapping), these words can be used as work area. Slave input data will be transferred from the PLC area assigned by DM m+1 and DM m+2.

4-3-2 Unit → PLC

The C200HW-PRT21 always provides 5 words of data to the host PLC's IR area. In Default Mode, this includes 2 words of slave output data.

Status information is transferred during each I/O refresh, irrespective of the state of the fieldbus system.

Unit Status Flags

IR n+3 contains status information concerning the Unit in general (upper byte), plus PROFIBUS-DP specific status information (lower byte).

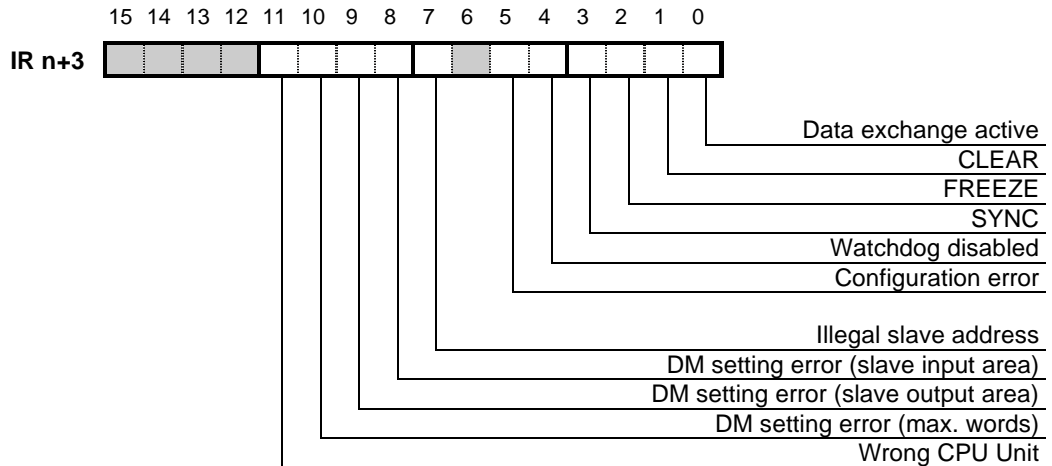

IR n+3.00 Data exchange active

0: The Slave Unit is not in data exchange mode.

Either the Slave Unit has not yet been parameterised and configured by a master after power-on, or the master has failed to communicate with the slave within the currently set watchdog time.

1: The Slave Unit is exchanging data with the PROFIBUS-DP master.

This does not necessarily mean that the slave I/O data is updated cyclically by the PROFIBUS-DP master unit:

- If the communication watchdog timer is disabled by the master (see IR n+3.04), the I/O data refresh interval may be of indefinite length.
- In FREEZE or SYNC mode, updating of in- and output data is controlled by global control commands.

IR n+3.01 CLEAR

0: Slave not in CLEAR mode.

1: The master has sent a global control command CLEAR, which sets all outputs of its assigned slaves on the network to their fail-safe state. All slave output data to the host PLC will be set to 0000. When the slave is in CLEAR mode, it accepts data exchange messages without data from its master (Fail-safe mode).

IR n+3.02 FREEZE

- 0: Slave not in FREEZE mode.
- 1: The slave has received a global control command FREEZE from its master. The slave input data from the PLC is not updated at the PROFIBUS-DP interface until the next FREEZE command is received, or until the slave receives an UNFREEZE command.

IR n+3.03 SYNC

- 0: Slave not in SYNC mode.
- 1: The slave has received a global control command SYNC from its master. The slave output data to the PLC is not updated at the PLC I/O bus interface until the next SYNC command is received, or until the slave receives an UNSYNC command.

IR n+3.04 Watchdog disabled

- 0: The slave's watchdog is enabled by the PROFIBUS-DP master. The actual watchdog time is indicated in IR n+5.

If the slave's I/O data is not refreshed by the master within the configured watchdog time, the slave will exit data exchange mode, and request the master to be provided with new parameter- and configuration data.

In this state, the Data exchange active flag (IR n+3.00) will be off, and all slave output data to the host PLC will be 0000.
- 1: The master has disabled the slave's watchdog. If the master-slave communication fails, the slave will not exit data exchange mode, and its outputs will keep their state as defined by the last received data exchange message.

IR n+3.05 Configuration error

- 0: The C200HW-PRT21 has received correct Chk_Cfg and Set_Prm messages from its master. The master's expected configuration matches the number of in- and output words assigned to the Unit, and the parameters sent by the master are accepted by the Unit.
- 1: The slave has not received (correct) configuration messages from a master unit, or a previously established connection was lost. I/O data exchange over PROFIBUS-DP will not take place until correct Set_Prm and Chk_Cfg messages have been received.

Check IR n+3.08~10 for DM setting errors, and compare the configuration data at the master with the Unit settings (See 4-2-1).

IR n+3.07 Illegal slave address

- 0: The Unit's PROFIBUS node address is set to a value in the range of 000 to 125.
- 1: The slave address is set outside the range of 000 to 125. The Unit cannot communicate on PROFIBUS-DP. Turn off the PLC, change the rotary switch settings and restart the Unit.

IR n+3.08 DM setting error (slave input area mapping)

- 0: No error.
- 1: There is an error in the slave input area mapping.
 - The DM settings contain an incorrect value for the start address of the input area in the PLC (DM m+1),
 - or the specified size (DM m+2) is incorrect, or it would make the data exceed the boundaries of the PLC data area.

The ERR LED is FLASHING to indicate a non-fatal error; PROFIBUS communication with the master is possible, but no data will be transferred from the host PLC to the input buffer. The slave's input data length will be set to 0.

Correct the DM settings and restart the Unit.

IR n+3.09 DM setting error (slave output area mapping)

- 0: No error.
- 1: There is an error in the slave output area mapping.
 - The DM settings contain an incorrect value for the start address of the output area in the PLC (DM m+4),
 - or the specified size (DM m+5) is incorrect, or it would make the data exceed the boundaries of the PLC data area.

The ERR LED is FLASHING to indicate a non-fatal error; PROFIBUS communication with the master is possible, but no data will be transferred from the output buffer to the host PLC. The slave's output data length will be set to 0.

Correct the DM settings and restart the Unit.

IR n+3.10 DM setting error (exceeding maximum number of words)

- 0: No error.
- 1: The total number of I/O words, defined by DM m+2 and m+5, exceeds the allowed maximum (i.e. 80 words for C200HS, 200 words for all other PLCs).

The ERR LED is ON to indicate a fatal error; PROFIBUS communication with the Unit is disabled.

IR n+3.11 Wrong CPU Unit

- 0: No error.
- 1: The Unit is mounted to a PLC type which does not support the C200HW-PRT21.

The ERR LED is ON to indicate a fatal error; PROFIBUS communication with the Unit is disabled.

Slave Parameter Data

IR n+4 and IR n+5 contain PROFIBUS-DP configuration data which the Slave Unit has received in the master unit's parameterisation message (Set_Prm).

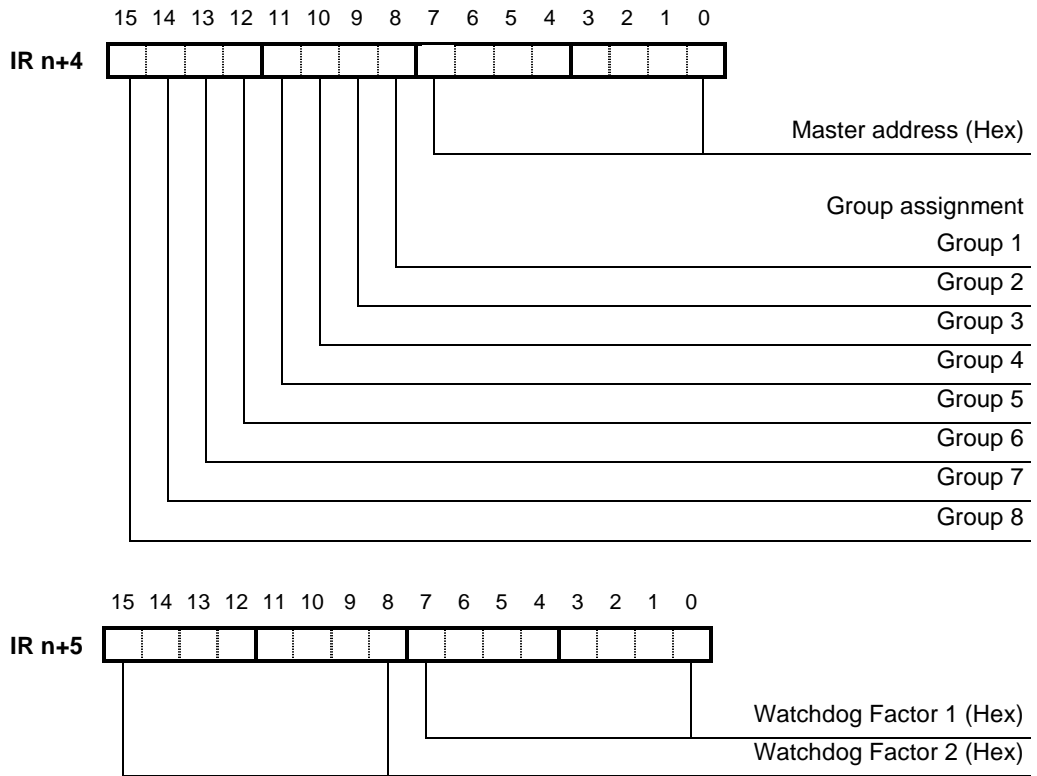

IR n+4 Master Address

Hexadecimal value (00h to 7Dh) indicating the bus address of the PROFIBUS-DP master from which the Unit has received and accepted the Set_Prm and Chk_Cfg messages.

A value FFh indicates that the slave has not been assigned to a master, or that the master has failed to communicate with the slave within the currently set watchdog time.

Group Assignment

Indicates to which Groups (numbered 1-8) the slave has been assigned by the PROFIBUS-DP master/configurator during parameterisation. Each slave may be assigned to any number of Groups.

- 0: Slave not assigned to Group x
- 1: Slave assigned to Group x

When receiving a global control command, the slave will determine if the command is intended for a group of slaves to which it has been assigned.

IR n+5 Watchdog Factors

The master's parameterisation message contains two factors which determine the value of the slave's communication watchdog timer.

Both Watchdog Factors 1 and 2 have a range of 1 to 255, with the restriction that they cannot both be 1. The watchdog factors are indicated as hexadecimal numbers (01h to FFh).

The watchdog time T_{wd} is defined as

$$T_{wd} = WDfact1 * WDfact2 * 10 \text{ ms,}$$

and thus can be set in the range of 20 to 650250 ms ($1*2*10$ to $255*255*10$).

0000h means that the slave has not been parameterised after power on.

The most recent watchdog factors that the unit has accepted from a master will be shown, even if the watchdog timer has expired due to interrupted master-slave communication.

Caution

The Slave will exit data exchange mode if the communication watchdog is enabled, and the time between two PROFIBUS-DP messages received from the master exceeds $T_{wd} + 10$ ms.

In this state, the Data exchange active flag (IR n+3.00) will be off, and all slave output data to the host PLC will be 0000. The slave needs to receive the correct Set_Prm and Chk_Cfg messages from the master to re-enter data exchange mode.

Slave Output Data

IR n+6 and IR n+7 may contain slave output data received via PROFIBUS-DP.

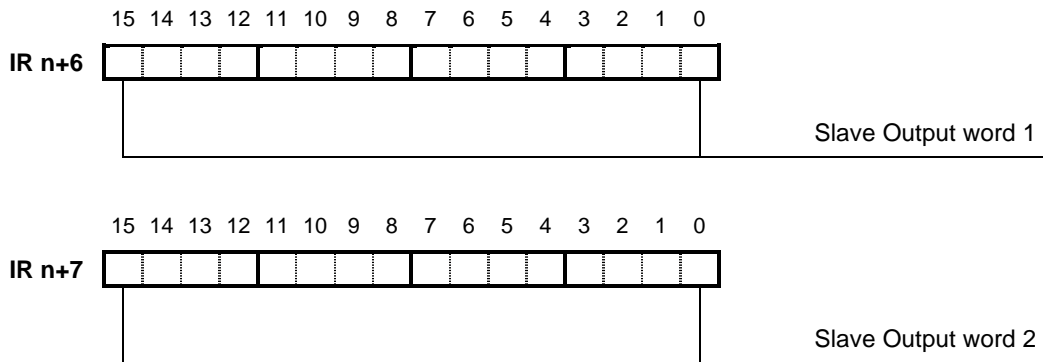

**IR n+6
IR n+7**

Slave Output words

In case DM m+3 is set to a value unequal to 0001 (i.e. default output data mapping), only these two words are used to transfer slave output data, received from PROFIBUS, to the host PLC.

If DM m+3 is set to 0001 (i.e. user defined output mapping), these two words will be set to the value **0000**. Slave output data will be transferred to the PLC area assigned by DM m+4 and DM m+5.

Caution

Before using the Slave output data in the PLC program, the user is to make sure the Unit Status Flags (in IR n+3) indicate that:

- PROFIBUS data exchange is active,
- there are no configuration errors.

and that the correct data format is selected (see section 4-2-2).

Otherwise the Slave Output words may contain invalid data.

4-4 LEDs

The Unit has four LED indicators to visualise its status. The layout of the LEDs is shown below.

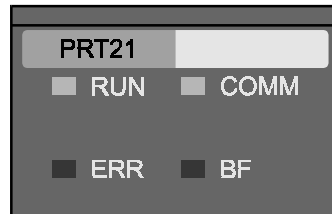

The two LEDs on the left side (RUN, ERR) show the status of the Unit in general, and the I/O bus interface in particular. The two LEDs on the right side indicate the status of the PROFIBUS-DP interface.

The different states of the LED indicators are listed in the tables below. In some states additional information is indicated by the status word IR n+3. The table refers to this status word where applicable.

Normal state

Normal operation status is indicated by the shaded areas.

Unit status LEDs

LED	Colour	State	Description
RUN	Green	OFF	Fatal error detected or no power supply
		Flashing	Initialising the Unit
		ON	The Unit was initialised, no fatal error detected
ERR	Red	OFF	No errors
		Flashing	Non-fatal error due to incorrect Unit settings. PROFIBUS communication is possible. Details in IR n+3.
		ON	Fatal error in the Unit settings or in the Host PLC interface. PROFIBUS communication will be disabled. Details in IR n+3.

PROFIBUS-DP status LEDs*

LED	Colour	State	Description
COMM	Green	OFF	No PROFIBUS-DP communication
		ON	I/O data exchange on PROFIBUS-DP is active (= status bit IR n+3.00).
BF (Bus Fail)	Red	OFF	No PROFIBUS-DP communication errors
		Flashing	The Unit communicates with a master, but is not correctly configured or parameterised.
		ON	Response monitoring time has elapsed. The PROFIBUS-DP master did not address the slave within the configured watchdog time.

*(only valid when RUN LED is ON, i.e. after initialisation)

SECTION 5

Troubleshooting and Maintenance

This section describes the troubleshooting procedures and maintenance operations needed to keep the PROFIBUS-DP network operating properly.

5-1	Error Indicators	40
5-2	Troubleshooting	40
5-3	Maintenance	43
5-3-1	Cleaning	43
5-3-2	Inspection	43
5-3-3	Addition/Replacement of Units	44

5-1 Error Indicators

The Unit provides the following error indicators:

- The status word IR n+3, which is transferred to the PLC IR area in every I/O refresh after initialisation of the Unit.
- The four LEDs at the front of the Unit: RUN, ERR, COMM and BF.

These indicators are described in Section 4-3-2 and Section 4-4.

5-2 Troubleshooting

Possible problems have been divided in the following categories:

- PLC Errors
- Start-up problems
- I/O data communication problems

PLC Errors

Description	Possible cause	Possible remedy
An I/O verification error occurred.	The current PLC configuration is not the same as it was when the I/O table was registered.	Check the I/O table with the I/O table verification operation and correct it if necessary. After correcting it, perform the I/O Table Create operation.
An I/O Unit Over error occurred.	The MACH No. rotary switch setting is incorrect.	Make sure that the setting does not exceed the maximum allowed Unit number. See section 3-1-2, Rotary Switches. If it does exceed the limit, adjust the Machine number and restart the Unit.
	Two Units claim the same Unit number.	Adjust the MACH No. switch setting and restart the Unit.
A Special I/O Unit error occurred.	The Unit is not connected properly or was removed while the power was on.	Turn the power off, make sure that the Unit is connected properly and turn the power on again.
An I/O Bus error occurred.	The Unit is not connected properly.	Turn the power off, make sure that the Unit is connected properly and turn the power on again.
	The Unit is defective	Replace the C200HW-PRT21.

Start-up problems

Description	Possible cause	Possible remedy
No LEDs are ON or Flashing	The PLC's power is off	Turn the PLC's power supply on.
	The Unit is defective.	Replace the C200HW-PRT21.
The RUN LED is Flashing	The same Unit number has been set on another Special I/O Unit, causing an I/O UNIT OVER error in the PLC.	Make sure that the same Unit number is not used by more than one Special I/O Unit and restart the PLC.
	I/O table verification error. A Unit has been removed or the Unit number setting has been changed that caused an I/O SET ERR error in the PLC.	Verify the I/O table and/or register the I/O table again.
	Another Special I/O Unit or Interrupt Input Unit has not been initialised, causing a CPU WAIT'G error in the PLC.	Check and/or remove the defective Unit.
	The Unit is defective.	Replace the C200HW-PRT21.
ERR LED is Flashing	A non-fatal error was detected at startup. The cause is reported in IR n+3	Try to solve the cause and restart the Unit. If this does not help, replace the Unit
ERR LED is ON	A fatal error was detected at startup. The cause is reported in IR n+3	Try to solve the cause and restart the Unit. If this does not help, replace the Unit

I/O data communication problems

Description	Possible cause	Possible remedy
<p>COMM LED is OFF and BF LED is ON</p>	<p>Control bit IR n.00 of the control words is OFF. The PROFIBUS communication is inhibited.</p>	<p>Set the Communication Enable bit IR n.00</p>
	<p>The PROFIBUS configuration is not correct.</p>	<p>Check IR n+3.05 (Configuration Error flag) Verify that the Unit has the same station address as in the master's configuration. Verify that the correct GSD-file (OC_04AC.GSD) is used in the master. Verify that no station address is used twice. Verify that the network has been configured to communicate at a baud rate supported by the Unit. Verify that the bus parameters have the correct value. After changing a configuration, download the configuration to the applicable master unit.</p>
	<p>The PROFIBUS wiring is not correct.</p>	<p>Verify that the correct pins of the BUS connector are connected, that there are no short circuits or line interruptions, the correct cable type is used, and that the stub lines are not too long (see section 3-3-1).</p>
	<p>The PROFIBUS network has not been terminated correctly.</p>	<p>Terminate the network at the appropriate places (see section 3-3-1).</p>
	<p>The PROFIBUS master unit is defective</p>	<p>Replace the master unit.</p>
<p>COMM LED is OFF and BF LED is flashing</p>	<p>The wiring is not correct.</p>	<p>Verify that the correct pins of the BUS connector are connected, that there are no short circuits or line interruptions, the correct cable type is used, and that the stub-lines are not too long (see section 3-3-1).</p>
	<p>Configuration is not correct.</p>	<p>Check IR n+3.05 (Configuration Error flag) Verify that the number of in- and output words in the master configuration match the DM settings of the Unit. Verify that the correct GSD-file (OC_04AC.GSD) is used in the master. Verify that the Unit has the same station address as in the master's configuration. Verify that no station address is used twice. Verify that the network has been configured to communicate at a baud rate supported by the Unit. After changing the configuration, download the configuration to the respective master unit.</p>
	<p>The I/O data mapping contains errors. The ERR LED is Flashing.</p>	<p>Verify that the Unit settings are correct. IR n+3.08-10 indicate the cause of the error. Compare the Unit settings with the master's configuration.</p>
	<p>The Slave Unit is defective.</p>	<p>Replace the C200HW-PRT21.</p>

I/O data communication problems (continued)

Description	Possible cause	Possible remedy
The COMM LED is ON, but no I/O data is exchanged with the PLC.	Either the input or output data size is set to 0.	Check the configuration at the master, and the validity of the Unit settings in the DM area.
	The I/O data mapping has been defined at the wrong PLC data area.	Make sure that the Unit settings are made in the correct DM memory area; the area depends on the Unit number setting.
	Another Special I/O Unit makes use of the same data area(s).	Check the mapping of the Unit and other Special I/O Units. If they overlap, then one Unit overwrites the data area of the other Unit and makes it look like that no data is being exchanged with the PLC. If an overlap exists, the Unit's DM settings should be changed.
	The slave operates in 'Sync' or 'Freeze'-mode.	In these modes, the I/O data is only updated after another transmission of the 'Sync' or 'Freeze' command. If this is not desired, these modes should be turned OFF by the master (Unsync/Unfreeze). Check IR n+3.
	Slave Unit is defective.	Replace the C200HW-PRT21.
No I/O data is exchanged with the PROFIBUS master	Slave is not connected properly.	Check the slave's connection to PROFIBUS. Are the correct pins connected, is the shield also connected, is the bus length not exceeded?
	The master unit or the transmission line have failed, the watchdog of the slave has switched the outputs of the slave to the fail-safe state.	Check the transmission line and master unit or disable the slave's watchdog (recommended for troubleshooting only).
	Slave Unit is defective.	Replace the C200HW-PRT21.

5-3 Maintenance

This section describes the routine cleaning and inspection recommended as regular maintenance.

5-3-1 Cleaning

Clean the PROFIBUS-DP Slave Units regularly as described below in order to keep it in optimal operating condition.

- Wipe the Unit with a dry, soft cloth for regular cleaning.
- When a spot cannot be removed with a dry cloth, dampen the cloth with a neutral cleanser, wring out the cloth, and wipe the Unit.
- A smudge may remain on the Unit from gum, vinyl, or tape that was left on for a long time. Remove the smudge when cleaning.

 **Caution** Never use volatile solvents such as paint thinner or benzene or chemical wipes. These substances could damage the surface of the Unit.

5-3-2 Inspection

Be sure to inspect the system periodically to keep it in its optimal operating condition. In general, inspect the system once every 6 to 12 months, but inspect more frequently if the system is used with high temperature or humidity or under dirty / dusty conditions.

Inspection Equipment

Prepare the following equipment before inspecting the system.

Required Equipment

Have a standard and Philips-head screwdriver, multimeter, alcohol, and a clean cloth.

Equipment that could be needed

Depending on the system conditions, a synchroscope, oscilloscope, thermometer, or hygrometer (to measure humidity) might be needed.

Inspection Procedure

Check the items in the following table and correct any items that are below standard.

Item		Standard	Equipment
Environmental conditions	Ambient temperature	0 to 55 °C	Thermometer
	Ambient humidity	10 to 90%	Hygrometer
	Dust/dirt accumulation	None	---
Installation	Are the Units installed securely?	No looseness	---
	Are the communications connectors fully inserted?	No looseness	---
	Are the external wiring screws tight?	No looseness	---
	Are the connecting cables undamaged?	No damage	---

5-3-3 Addition/Replacement of Units

Download new configuration

The PROFIBUS-DP network allows to connect and disconnect nodes while in operation. Only the addition of a new node to an existing configuration will require a new configuration file to be downloaded in the master unit, which may temporarily disable all communication by this master unit on PROFIBUS.

Plugging/unplugging of any node in a PROFIBUS-DP network is liable to result in a temporary increase of the communication cycle time.

Do not plug or unplug the C200HW-PRT21 on the PLC backplane while the PLC is powered. Doing so may result in damage to the Unit and/or the PLC system.

Appendix A

CS1 PLC series compatibility

The C200HW-PRT21 can also be installed in OMRON CS1 PLC systems, which provide a C200H-compatible I/O bus. However, the internal memory organisation in the CS1 PLC differs from that of the C200H series. The following table shows the relation between the C200H-series memory addresses used throughout this manual, and the corresponding addresses in the CS1 PLC series.

Function		instead of C200H addresses	CS1 will use addresses
Control & Status area	(MACH No.= 0 to 9)	IR100 ~ IR199	CIO2000 ~ CIO2159
	(MACH No.= A to F)	IR400 ~ IR459	
Unit settings		DM1000 ~ DM2599 or DM7000 ~ DM8599	D20000 ~ D21599
I/O data mapping areas		IR000 ~ IR235	CIO0000 ~ CIO0235
		IR300 ~ IR511	CIO0300 ~ CIO0511
		HR00 ~ HR99	HR000 ~ HR099
		LR00 ~ LR63	CIO1000 ~ CIO1063
		DM0000 ~ DM5999	D00000 ~ D05999
Error flag	(MACH No.= 0 to 9)	AR00.00 ~ AR00.09	AR418.00 ~ AR418.15
	(MACH No.= 0 to F)	IR280.00 ~ IR280.15	
Restart flag	(MACH No.= 0 to 9)	AR01.00 ~ AR01.09	AR502.00 ~ AR502.15
	(MACH No.= 0 to F)	IR281.00 ~ IR281.15	

Appendix B

GSD file for C200HW-PRT21

```

;*****
;**
;**      Omron Europe B.V.
;**
;**      European Headquarters
;**      Wegalaan 67-69
;**      NL-2132 JD Hoofddorp
;**      The Netherlands
;**
;**      European Technical Centre
;**      Zilverenberg 2
;**      NL-5234 GM 's-Hertogenbosch
;**      The Netherlands
;**
;*****
;**
;**      Device DataBase File for C200HW-PRT21 PLC I/O Slave
;**
;**      Filename:  OC_04AC.GSD
;**      Version :  9828REL01.0000
;**      Date      :  February 1, 2000
;**
;**      (C) Copyright OMRON Corporation 2000
;**      All Rights Reserved
;**
;*****
;**
;**      Important notice:
;**      =====
;**      - Any modification of parameters in this file may lead to undefined
;**        behavior of the Profibus-DP system.
;**
;*****
; General information *****/

#Profibus_DP
GSD_Revision      = 1
Vendor_Name       = "OMRON Corporation"
Model_Name        = "C200HW-PRT21"
Ident_Number      = 0x04AC
FMS_supp          = 0
Protocol_Ident    = 0
Station_Type      = 0
Slave_Family      = 10
Revision          = "V1.00"
Hardware_Release  = "V1.00"
Software_Release  = "V1.00"
Bitmap_Device     = "OC04AC_R"
Bitmap_Diag       = "OC04AC_D"
Bitmap_SF         = "OC04AC_S"

;
;
; GSD file revision 1.0.
;
; Vendor name string.
; Model type string.
; PNO Identification number.
;
; Profibus-FMS not supported.
; Profibus-DP supported.
; Station = DP-Slave.
; Slave family = 10 (PLC).
;
; Device revision 1.0.
; Hardware revision 1.0.
; Software revision 1.0.
;
; Bitmap RUNNING
; Bitmap DIAGNOSTIC
; Bitmap SPECIAL
;

```

```

; Specific implementation information *****/
Implementation_type = "SPC3"           ; Siemens SPC3 ASIC used.
Redundancy          = 0                ; Redundancy NOT supported.
Repeater_Ctrl_Sig   = 2                ; Supported, TTL level
24V_Pins            = 0                ; No external 24 Volt input.
;
Set_Slave_Add_supp  = 0                ; Station address is set
; through hardware address
; selectors.
; Media access information *****/
Auto_Baud_supp      = 1                ; Automatic baud rate select
; (SPC3 specific feature).
; Supported baud rates:
9.6_supp            = 1                ; 9600 Baud
19.2_supp           = 1                ; 19.2 kBaud
93.75_supp          = 1                ; 93.75 kBaud
45.45_supp          = 1                ; 45.45 kBaud
187.5_supp          = 1                ; 187.5 kBaud
500_supp            = 1                ; 500 kBaud
1.5M_supp           = 1                ; 1.5 MBaud
3M_supp             = 1                ; 3 MBaud
6M_supp             = 1                ; 6 MBaud
12M_supp            = 1                ; 12 MBaud
; Max. response times:
MaxTsdr_9.6         = 60               ; 60 Tbit = 6.25 msec.
MaxTsdr_19.2        = 60               ; 60 Tbit = 3.125 msec.
MaxTsdr_45.45       = 250              ; 250 Tbit = 5.50 msec.
MaxTsdr_93.75       = 60               ; 60 Tbit = 640 usec.
MaxTsdr_187.5       = 60               ; 60 Tbit = 320 usec.
MaxTsdr_500         = 100              ; 100 Tbit = 200 usec.
MaxTsdr_1.5M        = 150              ; 150 Tbit = 100 usec.
MaxTsdr_3M          = 250              ; 250 Tbit = 83 usec.
MaxTsdr_6M          = 450              ; 450 Tbit = 75 usec.
MaxTsdr_12M         = 800              ; 800 Tbit = 67 usec.
;
Min_Slave_Intervall = 5                ; Minimum slave interval =
; 0.5 msec.
;
; DP-slave information *****/
Freeze_Mode_supp    = 1                ; Freeze mode supported.
Sync_Mode_supp      = 1                ; Sync mode supported.
Fail_Safe           = 1                ; Fail safe supported.
;
Modular_Station     = 1                ; Modular station.
Max_Module          = 32               ; Maximum # of modules: 32.
;
Max_Input_Len       = 200              ; Maximum # of input bytes.
Max_Output_Len      = 200              ; Maximum # of output bytes.
Max_Data_Len        = 400              ; Maximum # of data bytes.
;
Max_Diag_Data_Len   = 6                ; Maximum diagnostic length.
;
; User parameter message definition *****/
User_Prm_Data_Len   = 3                ; Preset parameterization
; message length and default
; message.
User_Prm_Data        = 0x40,\          ; Mandatory additional user
; 0x00,\          ; parameters.
; 0x00
;
;
;

```

```
; Module definition list *****/
Module = "DEFAULT MODE" 0xF1           ; 2 words I/O.
EndModule                               ;
; Input definitions:
Module = " 1 word In" 0xD0             ; 1 word In.
EndModule                               ;
Module = " 2 words In" 0xD1           ; 2 words In.
EndModule                               ;
Module = " 4 words In" 0xD3           ; 4 words In.
EndModule                               ;
Module = " 8 words In" 0xD7           ; 8 words In.
EndModule                               ;
Module = "16 words In" 0xDF           ; 16 words In.
EndModule                               ;
; Output definitions:
Module = " 1 word Out" 0xE0           ; 1 word Out.
EndModule                               ;
Module = " 2 words Out" 0xE1         ; 2 words Out.
EndModule                               ;
Module = " 4 words Out" 0xE3         ; 4 words Out.
EndModule                               ;
Module = " 8 words Out" 0xE7         ; 8 words Out.
EndModule                               ;
Module = "16 words Out" 0xEF         ; 16 words Out.
EndModule                               ;
; I/O definitions:
Module = " 1 word In/Out" 0xF0       ; 1 word I/O.
EndModule                               ;
Module = " 2 words In/Out" 0xF1     ; 2 words I/O.
EndModule                               ;
Module = " 4 words In/Out" 0xF3     ; 4 words I/O.
EndModule                               ;
Module = " 8 words In/Out" 0xF7     ; 8 words I/O.
EndModule                               ;
Module = "16 words In/Out" 0xFF     ; 16 words I/O.
EndModule                               ;
; End of GSD file *****/
```

Index

A

Address, PROFIBUS slave, 10, 17, 34
Asynchronous, 12
Auto_Clear, 7

B

Baud rate, 6, 10, 20
BF (LED), 38
Broadcast, 5, 22
BUS (Connector), 18
BUS ADDRESS (Switches), 10, 17
Bus parameters, 8, 13, 22

C

C200HS I/O limitation, 28, 35
Cable, 3, 18
Clear (PROFIBUS state), 7, 33
COMM (LED), 16, 38, 40
Communication enable (control bit), 32
Configuration error (status flag), 34, 37, 41
Configurator, 8, 22, 36
Connector, PROFIBUS-, 18, 21
Consistency, 12
Control Bits, 31
CPU Unit
 Operation Mode, xii, xiv, 32
 Types, 17, 19, 27, 31, 35
CS1 PLC compatibility, 45
Cycle Time
 PLC, 12
 PROFIBUS, 6, 13

D

Data exchange active (status flag), 33
Data format, 30
Default Mode, 22, 27, 31
Device Data Base, 8, 47
Diagnostics, 6, 48
Dimensions, 11
DM setting error (status flags), 35

DM settings, 27

E

EMC, xvi, 10
EN50170, 2, 18, 19
Endian (little vs. big-), 30
ERR (LED), 16, 35, 38, 41
Error
 DM settings, 35
 Indicators, 16, 38
 Troubleshooting, 40

F

Fail-safe, 7, 33, 42
Files, Device Data Base, GSD, 8, 13, 22, 47
Freeze, 33, 34, 42

G

Global Control Commands, 33, 36
Grounding, xiv, 18, 21
Group assignment, 31, 36
GSD file, 8, 13, 22, 47

H

Humidity, xiii, 43

I

I/O
 Data areas, 22, 26, 32, 37
 Data format, 30
 Mapping, 28
 Refresh, xii, 12, 28, 31
Illegal slave address, 17, 34
Indicators, LEDs, 16, 38
 See also BF, COMM, ERR, RUN
Inductor, 21
Inputs
 Areas, 22, 26, 32
 Freeze, 33, 34, 42
Installation, 15
 EMC, xvi, 10
 Grounding, xiv, 18, 21
 Humidity, Temperature, xiii, 43

Intel/Motorola format, 30

IORF instruction, 28

L

LEDs, 16, 38

See also BF, COMM, ERR, RUN

Length, See Cable

Low Voltage Directive, xvi

M

MACH No. (Switch), 17, 27, 31, 40

Maintenance, 43

Mapping, 28

Master address, 31, 36

Minimum slave interval, 13

Motorola/Intel format, 30

Multicast, 5, 22

N

Network State, 7, 33, 38

See also Clear, Off-line, Operate, Stop

O

Off-line (PROFIBUS state), 7

Operate (PROFIBUS state), 7

OSI reference model, 3

Outputs

Areas, 22, 26, 32

Sync, 33, 34, 42

P

Performance, 5

PLC

CPU Types, 17, 19, 27, 31, 35

Cycle Time, 12

Polling, 5, 8, 12

Precautions, xi

PROFIBUS

Cable, 3, 18

Cycle Time, 6, 13

FMS, PA, 2

Profiles, 8

Standard, 2, 18, 19

R

Refresh, I/O, xii, 12, 28, 31

Repeater, 3, 18

Rotary switches, 17

RS-485, 3, 19

RTS, 18

RUN (LED), 16, 31, 38

S

Segment, PROFIBUS-, 18

Shielding, 18, 21

Slave parameter data

Group assignment, 31, 36

Master address, 31, 36

Watchdog factors, 31, 36

Special I/O Unit, 17, 19, 27

Specifications, 10

Bus cable, 3, 19

Stations

Active, Passive, 4

Replacing, 8, 43

Status Flags, 33

Stop (PROFIBUS state), 7

Switches, 17

Sync, 33, 34, 42

T

Temperature, xiii, 43

Termination, 18, 20, 21

Token, 5

Troubleshooting, 40

U

Unfreeze, 34, 42

Unit Settings, 27

Unsync, 34, 42

W

Watchdog, 7, 42

disabled (status flag), 7, 33

factors, 31, 36

Wrong CPU Unit (status flag), 35

Revision History

A manual revision code appears as a suffix to the catalog number on the front cover of the manual.

Cat. No. W901-E2-1

↑
Revision code

The following table outlines the changes made to the manual during each revision. Page numbers refer to the previous version.

Revision code	Date	Revised content
1	February 2000	Original production

