

Smart Sensor

Data Storage Unit

ZG2-DSU

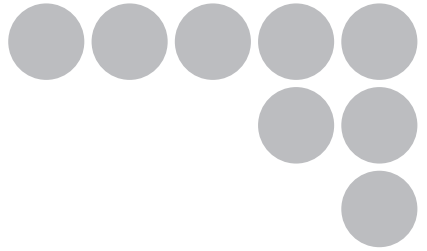

User's Manual



Introduction

Thank you for purchasing the ZG2 Data Storage Unit (ZG2-DSU).

This manual provides information regarding functions, performance and operating methods that are required for using the ZG2-DSU.

When using the ZG2-DSU, be sure to observe the following:

- The ZG2-DSU must be operated by personnel knowledgeable in electrical engineering.
- To ensure correct use, please read this manual thoroughly to deepen your understanding of the product.
- Please keep this manual in a safe place so that it can be referred to whenever necessary.

About Trademarks

- Microsoft and Windows are either registered trademarks or trademarks of Microsoft Corp. in the United States and/or other countries.
- CompactFlash is a trademark of SanDisk Corporation.
- Other product and company names herein may be either registered trademarks or trademarks of their respective owners.

■How to Switch the Display Language to English

Turn the power ON with the MENU key held down.

This displays the display language selection screen.



The unit will start up with the messages displayed in English when it is next started up.

User's Manual

READ AND UNDERSTAND THIS DOCUMENT (Please Read)

BEFORE USE

1

LOGGING FUNCTIONS

2

EXTERNAL BANK FUNCTIONS

3

SETTING ADDITIONAL FUNCTIONS

4

COMMUNICATION WITH EXTERNAL DEVICES

5

APPENDICES

6

Smart Sensor

Data Storage Unit
ZG2-DSU

READ AND UNDERSTAND THIS DOCUMENT

Please read and understand this document before using the products. Please consult your OMRON representative if you have any questions or comments.

WARRANTY

OMRON's exclusive warranty is that the products are free from defects in materials and workmanship for a period of one year (or other period if specified) from date of sale by OMRON.

OMRON MAKES NO WARRANTY OR REPRESENTATION, EXPRESS OR IMPLIED, REGARDING NON-INFRINGEMENT, MERCHANTABILITY, OR FITNESS FOR PARTICULAR PURPOSE OF THE PRODUCTS. ANY BUYER OR USER ACKNOWLEDGES THAT THE BUYER OR USER ALONE HAS DETERMINED THAT THE PRODUCTS WILL SUITABLY MEET THE REQUIREMENTS OF THEIR INTENDED USE. OMRON DISCLAIMS ALL OTHER WARRANTIES, EXPRESS OR IMPLIED.

LIMITATIONS OF LIABILITY

OMRON SHALL NOT BE RESPONSIBLE FOR SPECIAL, INDIRECT, OR CONSEQUENTIAL DAMAGES, LOSS OF PROFITS OR COMMERCIAL LOSS IN ANY WAY CONNECTED WITH THE PRODUCTS, WHETHER SUCH CLAIM IS BASED ON CONTRACT, WARRANTY, NEGLIGENCE, OR STRICT LIABILITY.

In no event shall responsibility of OMRON for any act exceed the individual price of the product on which liability is asserted.

IN NO EVENT SHALL OMRON BE RESPONSIBLE FOR WARRANTY, REPAIR, OR OTHER CLAIMS REGARDING THE PRODUCTS UNLESS OMRON'S ANALYSIS CONFIRMS THAT THE PRODUCTS WERE PROPERLY HANDLED, STORED, INSTALLED, AND MAINTAINED AND NOT SUBJECT TO CONTAMINATION, ABUSE, MISUSE, OR INAPPROPRIATE MODIFICATION OR REPAIR.

SUITABILITY FOR USE

THE PRODUCTS CONTAINED IN THIS DOCUMENT ARE NOT SAFETY RATED. THEY ARE NOT DESIGNED OR RATED FOR ENSURING SAFETY OF PERSONS, AND SHOULD NOT BE RELIED UPON AS A SAFETY COMPONENT OR PROTECTIVE DEVICE FOR SUCH PURPOSES.

Please refer to separate catalogs for OMRON's safety rated products.

OMRON shall not be responsible for conformity with any standards, codes, or regulations that apply to the combination of products in the customer's application or use of the product.

At the customer's request, OMRON will provide applicable third party certification documents identifying ratings and limitations of use that apply to the products. This information by itself is not sufficient for a complete determination of the suitability of the products in combination with the end product, machine, system, or other application or use.

The following are some examples of applications for which particular attention must be given. This is not intended to be an exhaustive list of all possible uses of the products, nor is it intended to imply that the uses listed may be suitable for the products:

- Outdoor use, uses involving potential chemical contamination or electrical interference, or conditions or uses not described in this document.

- Nuclear energy control systems, combustion systems, railroad systems, aviation systems, medical equipment, amusement machines, vehicles, safety equipment, and installations subject to separate industry or government regulations.
- Systems, machines, and equipment that could present a risk to life or property.

Please know and observe all prohibitions of use applicable to the products.

NEVER USE THE PRODUCTS FOR AN APPLICATION INVOLVING SERIOUS RISK TO LIFE OR PROPERTY WITHOUT ENSURING THAT THE SYSTEM AS A WHOLE HAS BEEN DESIGNED TO ADDRESS THE RISKS, AND THAT THE OMRON PRODUCT IS PROPERLY RATED AND INSTALLED FOR THE INTENDED USE WITHIN THE OVERALL EQUIPMENT OR SYSTEM.

PERFORMANCE DATA

Performance data given in this document is provided as a guide for the user in determining suitability and does not constitute a warranty. It may represent the result of OMRON's test conditions, and the users must correlate it to actual application requirements. Actual performance is subject to the OMRON Warranty and Limitations of Liability.

CHANGE IN SPECIFICATIONS

Product specifications and accessories may be changed at any time based on improvements and other reasons.

It is our practice to change model numbers when published ratings or features are changed, or when significant construction changes are made. However, some specifications of the product may be changed without any notice. When in doubt, special model numbers may be assigned to fix or establish key specifications for your application on your request. Please consult with your OMRON representative at any time to confirm actual specifications of purchased products.

DIMENSIONS AND WEIGHTS

Dimensions and weights are nominal and are not to be used for manufacturing purposes, even when tolerances are shown.

ERRORS AND OMISSIONS

The information in this document has been carefully checked and is believed to be accurate; however, no responsibility is assumed for clerical, typographical, or proofreading errors, or omissions.

PROGRAMMABLE PRODUCTS

OMRON shall not be responsible for the user's programming of a programmable product, or any consequence thereof.

COPYRIGHT AND COPY PERMISSION

This document shall not be copied for sales or promotions without permission.

This document is protected by copyright and is intended solely for use in conjunction with the product. Please notify us before copying or reproducing this document in any manner, for any other purpose. If copying or transmitting this document to another, please copy or transmit it in its entirety.

Meanings of Signal Words

The following signal words are used in this manual.



Indicates a potentially hazardous situation which, if not avoided, will result in minor or moderate injury, or may result in serious injury or death. Additionally there may be significant property damage.

Meanings of Alert Symbols

The following alert symbols are used in this manual.



Indicates the possibility of explosion under specific conditions.



This product has a built-in lithium battery. This battery might, in rare cases, ignite or rupture, and cause major injury.

Do not disassemble, pressurize, or incinerate this product at a temperature of 100°C or more.



Precautions for Safe Use

The following points are important to ensure safety, so make sure that they are strictly observed.

1. Installation Environment

- Do not use the product in environments where it can be exposed to inflammable/explosive gas.
- To secure the safety of operation and maintenance, do not install the product close to high-voltage devices and power devices.

2. Power Supply and Wiring

- The voltage and AC power supply must be within the rated range (DC 24 V \pm 10%).
- Reverse connection of the power supply is not allowed.
- Open-collector outputs should not be short-circuited.
- Use the power supply within the rated load.
- High-voltage lines and power lines must be wired separately from this product. Wiring them together or placing in the same duct may cause induction, resulting in malfunction or damage.

3. Regulations and Standards

- EN61326-1
- Electromagnetic environment : Industrial electromagnetic environment (EN/IEC 61326-1 Table 2)
- Notice for Korea Radio Law

A 급 기기 (업무용 방송통신기자재)

이 기기는 업무용 (A 급) 전자파적합기기로서 판매자 또는 사용자는 이 점을 주의하시기 바라며 , 가정외의 지역에서 사용하는 것을 목적으로 합니다.

4. Other

- Do not disassemble, repair, or modify the product.
- Dispose of this product as industrial waste.

Precautions for Correct Use

Observe the following precautions to prevent failure to operate, malfunctions, or undesirable effects on product performance.

1. Installation Site

Do not install this product in locations subjected to the following conditions:

- Ambient temperature outside the rating
- Rapid temperature fluctuations (causing condensation)
- Relative humidity outside the range of 35 to 85%
- Presence of corrosive or flammable gases
- Presence of dust, salt, or iron particles
- Direct vibration or shock
- Reflection of intense light (such as other laser beams or electric arc-welding machines)
- Direct sunlight or near heaters
- Water, oil, or chemical fumes or spray
- Strong magnetic or electric field

2. Power Supply and Wiring

- When using a commercially available switching regulator, make sure that the FG terminal is grounded.
- If surge currents are present in the power lines, connect surge absorbers that suit the operating environment.
- Before turning ON the power after the product is connected, make sure that the power supply voltage is correct, there are no incorrect connections (e.g. load short-circuit), and the load current is appropriate. Incorrect wiring may result in breakdown of the product.
- Before connecting/disconnecting devices, make sure that the devices are turned OFF. The devices may break down if it is connected/disconnected while the power is ON.
- Use only combinations of the Sensor Controller specified in this manual.

3. Maintenance and Inspection

Do not use thinner, benzene, acetone or kerosene to clean the Data Storage Unit.

4. Compatibility of Measurement Data

This product is the dedicated data storage unit for ZG2 series.

Data cannot be logged when existing ZG series products are connected to the Data Storage Unit.

Bank data or System data saved using ZG series cannot be processed with this product.

Editor's Note

■ Meaning of Symbols

Menu items that are displayed on the Data Storage Unit's LCD screen, and windows, dialog boxes and other GUI elements displayed on the PC are indicated enclosed by brackets "[]".

■ Visual Aids

Important

Indicates points that are important to achieve the full product performance, such as operational precautions or tips.

Note

Provide helpful information in use.



Indicates pages where related information can be found.

MEMO

CONTENTS

1. BEFORE USE

Data Storage Unit	14
System Configuration	14
Part Names and Functions	15
Mounting and Connecting Devices	17
Gang-mounting to a Controller	18
Attaching the Ferrite Core	19
Connecting the Power Supply	19
Inserting and Removing Memory Cards	20
Functions of the Data Storage Unit	22
Logging Function	22
External Bank Function	22
Initializing Controller Settings	23
Saving Setup Data	24

2. LOGGING FUNCTIONS

Logging Procedure	26
How Logging Works	27
Possible Number of Logging Data	28
Format of Data Saved to Memory Card	29
Select the Logging Target	31
Logging Measurement Values	31
Logging Profiles	31
Setting Logging Conditions	32
Logging Only at an NG/Only at an OK	32
Logging by All Conditions	32
Logging at a Fixed Cycle	33

Logging at Individual Fixed Counts	33
Specify the Logging Cycle by an External Signal	33
Starting and Ending Logging	34
Starting Logging	34
Ending Logging	34
Loading Logging Data to an External Device	35
Removing the Memory Card and Copying Logging Data	35
Copying Logging Data by Serial Communication Com-	
mands	35

3.EXTERNAL BANK FUNCTIONS

Saving Bank Data to Memory Cards	38
Transferring Bank Data to the Controller	39

4.SETTING ADDITIONAL FUNCTIONS

Judging Measurement Values (Alarm Outputs)	42
Specifying Tasks	42
Setting Judgment Conditions	42
Setting System Conditions	44
Setting the System Clock	44
Locking Keys	44
Memory Card Operations	44
Changing the Display Language	45
Displaying Data Storage Unit Information	45
Display Settings during Operation	46
Setting the Digital Display	46
LCD Screen Settings	47
Bank Functions	49
Switching Banks	49
Clearing Banks	49

5.COMMUNICATION WITH EXTERNAL DEVICES

List of Output Data	52
Communication Using I/O Signals	53
Using the Controller I/O Cable	53
Timing Charts	56
Logging	56
Transferring Bank Data	57
Alarm Output	57
Serial Communication	58
RS-232C Specifications	58
Communication Commands	59
Measurement Value Acquisition/Profile Acquisition Com- mands	61
Bank Data Transfer Commands	65
Setting Acquisition/Change Commands	66
Bank Control Commands	69
Utility Commands	70
Parameter List	71

6.APPENDICES

Specifications and External Dimensions	74
Data Storage Unit	74
Error Messages and Corrective Actions	77
Menu List	79
Basic Knowledge for Operation	81
How to Select Menus	81
Updating the Firmware	83
INDEX	85
Revision History	88

BEFORE USE

Data Storage Unit	14
Mounting and Connecting Devices	17
Functions of the Data Storage Unit	22
Initializing Controller Settings	23
Saving Setup Data	24

Data Storage Unit

The Data Storage Unit collects and acquires measurement values and profiles from the Sensor Controller installed on site, and can save this data to Memory Card. Data saved on Memory Card can be easily loaded to a PC for use in data analysis and operations.

Measurement conditions for up to 4096 banks (16 banks x 256 files) can be registered to an inserted Memory Card as an external bank for the Sensor Controller. Also, thresholds can be set for data currently being logged and used as alarm output functions.

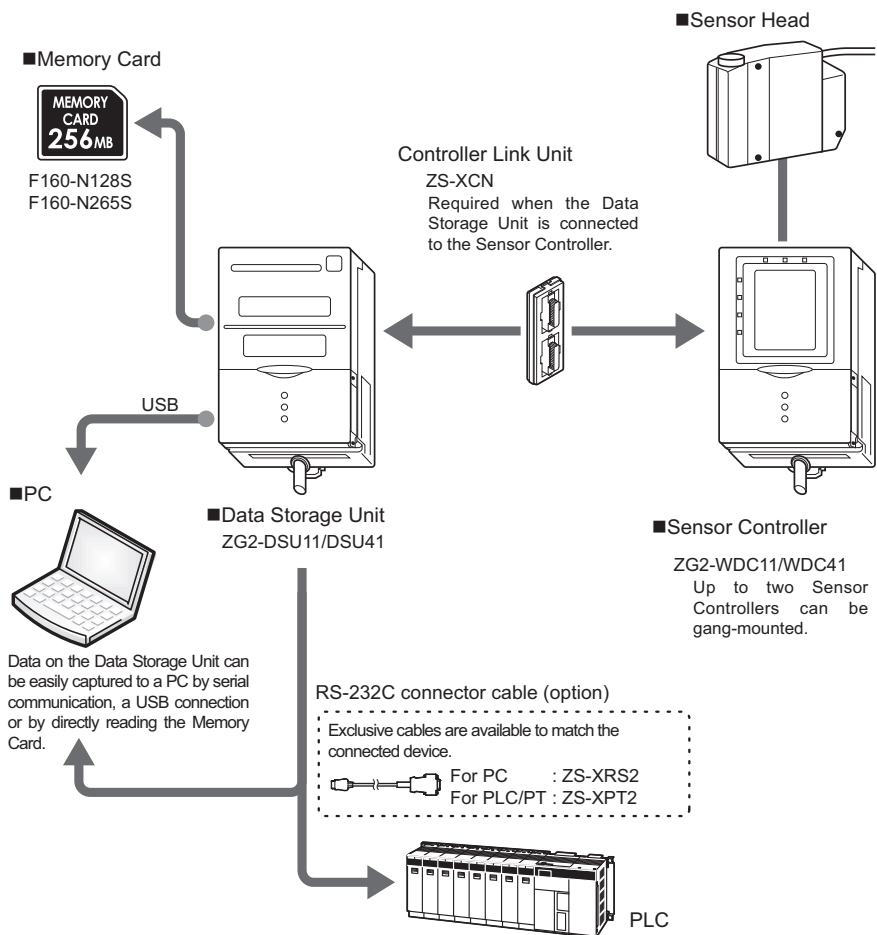

System Configuration

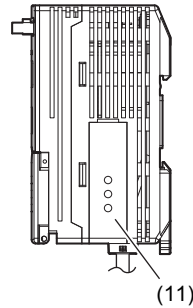
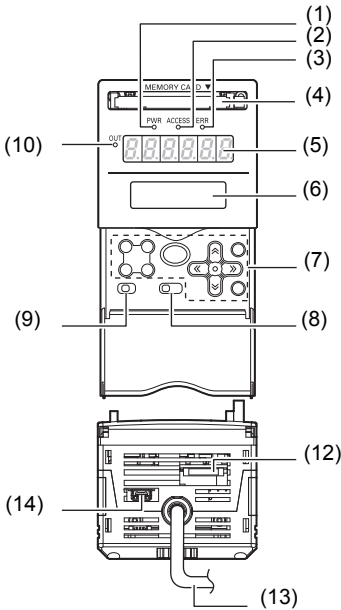

Part Names and Functions



Name	Function	
(1) CF power LED	Displays the status of the power supplied to the Memory Card. This LED turns ON when power is ON, and turns OFF when power is OFF.	
(2) CF access LED	This LED turns ON when the Memory Card is being accessed.	
(3) Error LED	This LED turns ON when a Memory Card read/write error occurs.	
(4) Memory Card slot	This slot is for inserting the Memory Card.	
(5) Digital display	This displays measurement values currently being logged, remaining amount of space on the Memory Card, and other information.	
(6) LCD screen	FUN mode	This mode displays the menu for setting logging conditions.
	TEACH mode	This mode displays the menu for setting alarm output thresholds.
	RUN mode	This mode displays the menu for setting up the content of the digital display and other display-related settings. Settings for using the Memory Card as an external bank are also made in this mode.

Name	Function
(7) Control keys	<p>These keys are for setting logging conditions and other information. Control key functions change according to the selected operation mode.</p> <p> List of Key Operations p.82</p>
(8) Mode switch	<p>This switch selects the operation mode.</p> <p>FUN: This mode displays the menu for setting logging conditions.</p> <p>TEACH: This mode displays the menu for setting alarm output thresholds.</p> <p>RUN: Normally select this mode when performing logging.</p>
(9) Threshold selection switch	<p>Select which of the HIGH or LOW thresholds is to be set (or displayed).</p>
(10) OUT LED	<p>This LED turns ON during alarm output.</p>
(11) Gang mount	<p>Use this connector for connecting the Data Storage Unit to the Controller Link Unit.</p>
(12) RS-232C connector	<p>Connect the RS-232C cable (exclusive product) when you are connecting the Data Storage Unit to a personal computer which does not have a USB port.</p> <p> RS-232C cable p.14</p>
(13) I/O cable	<p>Connect this cable to the power supply.</p>
(14) USB port	<p>Connect the USB cable (MINI-B) to the USB port to connect to a personal computer.</p>

Mounting and Connecting Devices

This section describes installation of the Data Storage Unit.

Cautions Regarding the Mounting Orientation

To improve heat radiation, install the Data Storage Unit only in the orientation shown below.

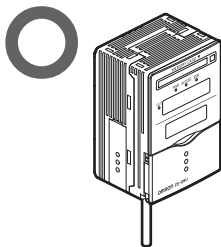

Do not install the Data Storage Unit in the following orientations:

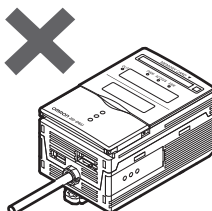
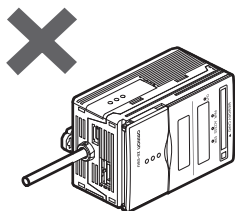

Important

- Do not block the ventilation holes at the top and bottom of the Data Storage Unit body. Doing so will cause heat to build up inside and result in a malfunction.
- When the temperature inside the control panel exceeds the ambient temperature of 50°C, provide forced-air cooling or more space at surrounding areas, or improve air circulation to lower the ambient temperature to 50°C or less.

Gang-mounting to a Controller



For details on how to gang-mount and install devices, refer to the ZG2 series User's Manual.

CH number when Controllers are gang-mounted

In the gang-mounted arrangement, the Data Storage Unit must be located at the leftmost end viewed from the front.

When the unit is gang-mounted, the CH number is assigned automatically.

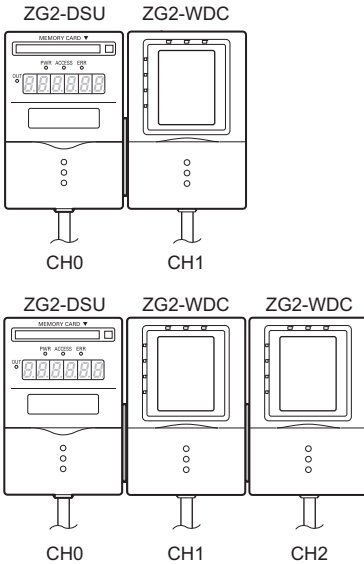

Attaching the Ferrite Core

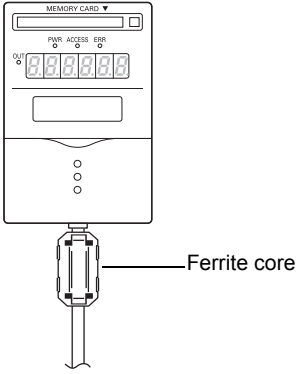

- 1 Attach the ferrite core (supplied) to the Data Storage Unit's I/O cable.

Connecting the Power Supply

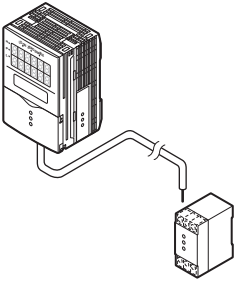

- 1 Connect the power wire (brown) and GND wire (blue) of the Sensor Controller's I/O cable to the 24 VDC ($\pm 10\%$) power supply.

Note

The following power supply is recommended:

- S8VS-03024 (24 VDC, 1.3 A)

Be sure to connect the Data Storage Unit to the power supply in a 1:1 connection.

Inserting and Removing Memory Cards

Important

The following Memory Cards can be used on this unit.

- F160-N128S (128 MB)
- F160-N256S (256 MB)

Inserting Memory Cards

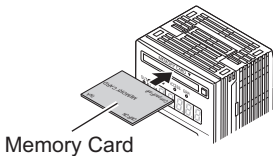
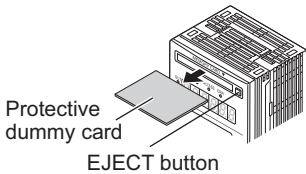

- 1** Press the EJECT button at the side of the Memory Card slot.
- 2** Remove the protective dummy card from the unit.
- 3** Insert the Memory Card.

Removing Memory Cards

Important

Before removing a Memory Card from the unit, make sure that the CF power LED and access LED are both OFF. If a Memory Card is removed with these LEDs still ON, there is the possibility that data stored on the Memory Card might be lost or the Memory Card or Data Storage Unit might malfunction.

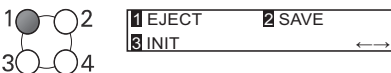
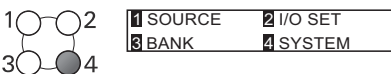
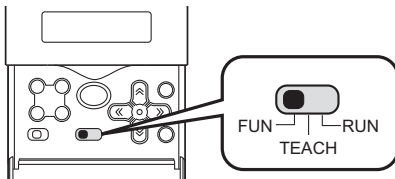

- 1** Switch to the FUN mode.
- 2** Select [SYSTEM].
- 3** Select [EJECT].

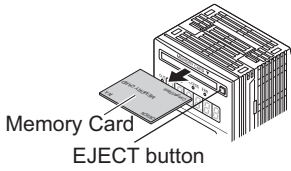
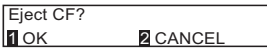

4 Select [OK].
The CF power LED turns OFF.

5 Press the EJECT button at the side of the Memory Card slot.

6 Remove the Memory Card.

Important

When Memory Cards are not to be used on the unit for a long time, insert the protective dummy card.

Functions of the Data Storage Unit

Logging Function

Measurement values and profile data can be saved on the Data Storage Unit. Saved data can be loaded to a PC from a Memory Card or via USB/serial communication for use in managing production logs, monitoring trends and analyzing trouble that may occur.

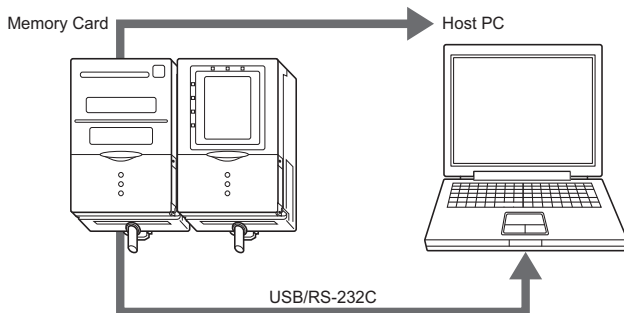



Logging is performed according to the following five conditions:

- Only at an NG/only at an OK p.32
- All conditions p.32
- At a fixed cycle p.33
- At individual fixed counts p.33
- At a logging cycle specified by an external signal p.33

External Bank Function

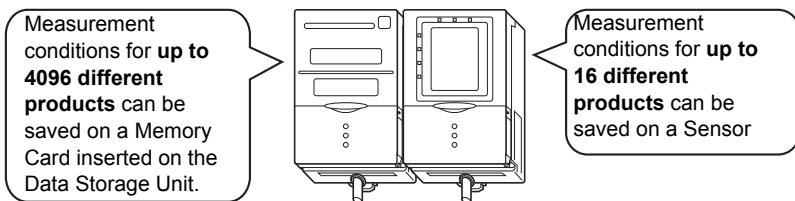
The Data Storage Unit can be used as an external bank for the Sensor Controller. Measurement conditions for up to 4096 banks can be registered to an inserted Memory Card, which enables a speedy response on multi-product production lines.



 Saving bank data to Memory Cards p.38

 Transferring bank data to the Controller p.39

Initializing Controller Settings

Important

The settings of all banks and logging data are initialized regardless of the currently saved bank No. and logging data. To save settings and data, back them up to a personal computer before performing initialization.

 Acquiring setup data <DATAGET command> p.66

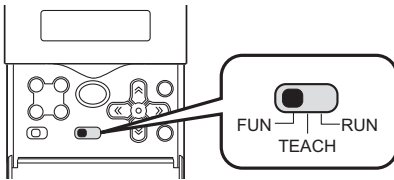

1 Switch to the FUN mode.

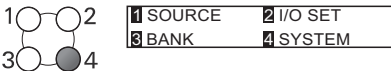

2 Select [SYSTEM].

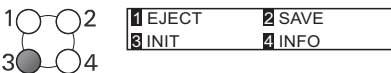

3 Select [INIT].

The confirmation message is displayed.

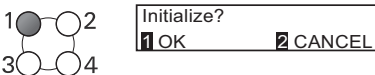

4 Select [OK].

The final confirmation message is displayed.

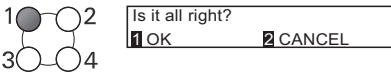

5 Select [OK].

The settings are initialized, and the "INITIALIZE Executed" message is displayed.

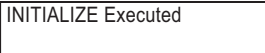

Saving Setup Data

Bank settings and system settings made on the Data Storage Unit can be saved internally on the Data Storage Unit.

Important

- The settings of all banks are saved regardless of the currently selected bank No.
- After you have made settings, be sure to save the setup data. All settings will be deleted if you turn the power OFF without saving the data. A message prompting you to save data will be displayed if you change the operation mode without saving data after you have changed settings.

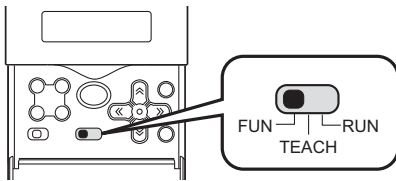

1 Switch to the FUN mode.



2 Select [SYSTEM].

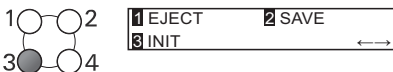

3 Select [SAVE].

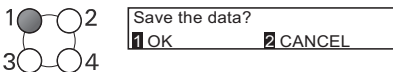

4 Select [OK].

The final confirmation message is displayed.

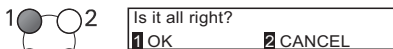

5 Select [OK].

The settings are saved, and the "SYSTEMDATA SAVE Executed" message is displayed.



LOGGING FUNCTIONS

Logging Procedure	26
How Logging Works	27
Select the Logging Target	31
Setting Logging Conditions	32
Starting and Ending Logging	34
Loading Logging Data to an External Device	35

Logging Procedure

Step 1

Select the logging target.



Measurement value p.31



Profile p.31

Step 2

Set conditions to be used for logging.



Only at an NG/only at an OK p.32



Log by all conditions p.32



Log at a fixed cycle p.33



Log at individual fixed counts p.33



Specify the logging cycle by an external signal p.33

Step 3

Start logging.



Starting logging p.34

Step 4

End logging.



Ending logging p.34

Step 5

Load logging data to the PC.



Removing the Memory Card and copying logging data to a PC p.35



Loading logging data to a PC by serial communication commands p.35

How Logging Works

The Data Storage Unit logs measurement values and profiles by the following mechanism.

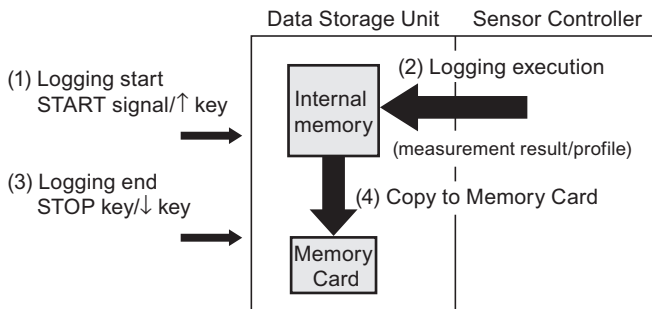

Process	Description
(1) Logging start	Logging is started by the START signal or by the ↑ key.
(2) Logging execution	Measurement results and profiles are logged to the ZG2-DSU's internal memory in accordance with preset logging conditions.
(3) Logging end	Logging is ended by the STOP signal or by the ↓ key.
(4) Copy to Memory Card	Logging data is copied automatically after logging ends to the Memory Card from the ZG2-DSU's internal memory.

Note

Approximate time required for copying logging data to Memory Card

 Timing charts p.56

Possible Number of Logging Data

Possible Number of Logs to Internal Memory

Logged Data	Number of Saves to Internal Memory
Measurement values only	Max. 65,000 times (*1)
Profiles only	Max. 5,120 times (*2)
Both measurement values and profiles	Max. total 5,120 times (*2)

*1 Logging is possible up to 65,000 times regardless of the number of connected Sensor Controllers and number of preset tasks. When the number of saves reaches 65,000 times, logged data is overwritten starting with the oldest data.

*2 When the number of saves reaches 5,120 times, logged data is overwritten starting with the oldest data.

Possible Number of Saves to Memory Card

When logging ends, logged data is saved to Memory Card as a single file.

The possible number of saves differs according to the amount of remaining space on the Memory Card, number of connected Sensor Controllers and the number of preset tasks.

Refer to the following table.

Logged Data	Setting	Number of Saves to 256 MB Memory Card
Measurement values only	2 CH x 8 tasks	Max. 1.3 million times (65,000 times x 20 files)
	1 CH x 1 task	Max. 7.15 million times (65,000 times x 110 files)
Profiles only	1 CH only	Max. 35,328 times (256 times x 138 files)
Both measurement values and profiles (1 channel)	-	Max. total 30,720 times (256 times x 120 files) regardless of preset number of tasks

Important

The numerical values in the table above are provided for reference only. Please note that the number of saves may fluctuate depending on the setup status even with the same number of channels or tasks.

Format of Data Saved to Memory Card

When logging is executed, the "OMRON" folder for storing data is automatically created on the Memory Card. Each time logging starts and ends, folders are automatically created and appended with a running number, and logging data is automatically stored in each of these folders.

Folder structure

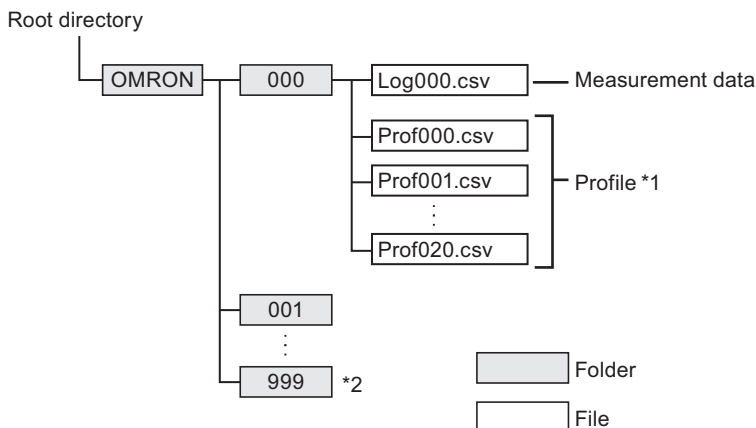

*1 Up to 5,120 profiles can be logged to internal memory. However, when these profiles are saved to Memory Card, the profiles are split up into 256 profiles for each individual file. The same number as the folder name is used for the number appended to each file name.

*2 The maximum number of folders that can be created is 999. The logging folder start No. can also be changed.

 Changing the logging folder start No. p.45

File Format

Measurement value

One measurement value is output to one row of the file.

Log____.csv

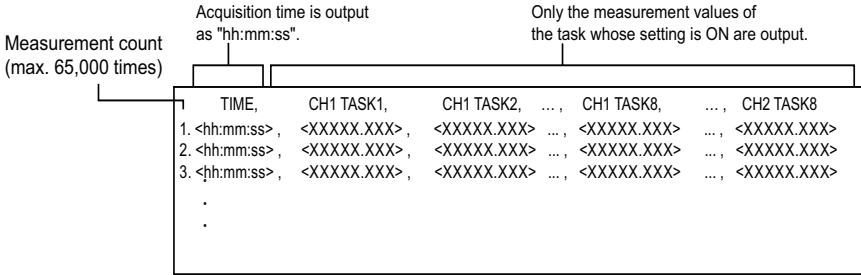

Profile

One profile data is output to one column of the file.

Prof____.csv

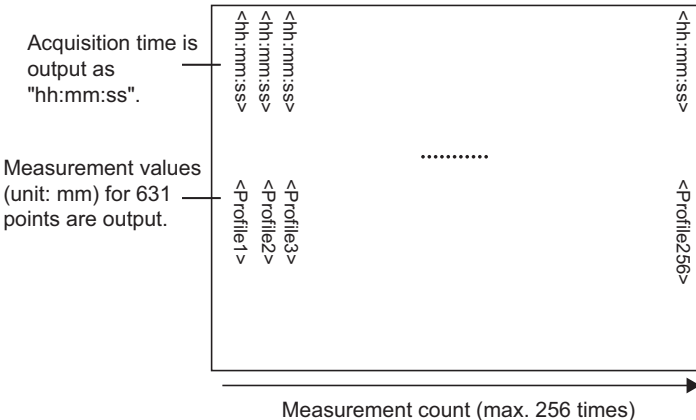

Note

Up to 5,120 profiles can be logged to internal memory. However, when these profiles are saved to Memory Card, the profiles are split up into 256 profiles for each individual file.

Select the Logging Target

Measurement values and profiles can be selected as logging targets.

Logging Measurement Values

► **FUN mode-[SOURCE]-[VALUE]-[CH1 or CH2]-[TASK1 to TASK8]**

Setting value	Description
OFF/ON	Sets the channel (CH) and task No. of the Sensor Controller targeted for logging to ON.

Note

CH2 is not displayed when it is not connected.

Logging Profiles

► **FUN mode-[SOURCE]-[PROFILE]**

Setting value	Description
OFF/CH1/CH2	Sets the channel (CH) of the Sensor Controller targeted for logging.

Important

When two Sensor Controllers are gang-mounted, profiles are logged on only either one of the Sensor Controllers.

Setting Logging Conditions

Set which data is to be logged. You can select from the following five logging conditions.

- Only at an NG/only at an OK
- All conditions
- At a fixed cycle
- At individual fixed counts
- At a logging cycle specified by an external signal

Logging Only at an NG/Only at an OK

Set logging according to the judgment result of a specific Sensor Controller.

► FUN mode-[SOURCE]-[LOGGING]-[MEAS]

Setting value	Description
CH	Selects the channel of the Sensor Controller whose judgment result is to be monitored.
JUDGE	NG+ERROR: Logging is performed only when the overall judgment of the CH currently being monitored is NG and ERROR. NG: Logging is performed only when the overall judgment of the CH currently being monitored is NG. PASS: Logging is performed only when the overall judgment of the CH currently being monitored is PASS (OK). (default value)

Logging by All Conditions

Logging is performed by all conditions regardless of judgment result.

► FUN mode-[SOURCE]-[LOGGING]-[MEAS]

Setting value	Description
CH	Select the channel of the connected Sensor Controller. When two Controllers are connected, either Sensor Controller may be selected.
JUDGE	Select [All].

Logging at a Fixed Cycle

Logging is performed at a specified time cycle.

► FUN mode-[SOURCE]-[LOGGING]-[TIME]

Setting value	Description
00:00:00	Specifies the time interval.

Logging at Individual Fixed Counts

Logging is performed at a specified count interval.

► FUN mode-[SOURCE]-[LOGGING]-[POINT]

Setting value	Description
1 - 999,999	Sets the count interval. (default value: 1)

Specify the Logging Cycle by an External Signal

All data is logged continuously for the duration that the TRIG signal is ON.

Note

- Logging is also performed while function key 1 is held down.
- This key can be used as a substitute for the trigger signal.

► FUN mode-[SOURCE]-[LOGGING]-[TRIGGER]

Starting and Ending Logging

The following describes the procedure for starting and ending logging.

Starting Logging

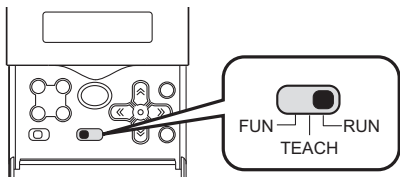

1 Switch to the RUN mode.

Available MB ←→
Stopping ↑ START

2 Either input the START signal or press the ↑ key.
Logging is started.

Note

Display details during logging can be changed by the ←→ keys.



Ending Logging

1 Either input the STOP signal or press the ↓ key.
Logging ends, and data is saved to the Memory Card.

Important

The Data Storage Unit cannot accept the next logging operation while data is being saved to the Memory Card.

Whether or not start of logging can be accepted can be known by the BUSY signal.

 Timing charts p.56

Loading Logging Data to an External Device

There are two ways of loading logging data stored on Memory Card to an external device.

Removing the Memory Card and Copying Logging Data

Important

Before removing a Memory Card from the unit, make sure that the CF power LED and access LED are both OFF. If a Memory Card is removed with these LEDs still ON, there is the possibility that data stored on the Memory Card might be lost or the Memory Card or Data Storage Unit might malfunction.

 Removing Memory Cards p.20

Copying Logging Data by Serial Communication Commands

Logging data can be copied by input of communication commands from an external device without removing the Memory Card.

By using the command for initializing the Memory Card after a copy, data after the copy can be deleted to secure free space on the Memory Card for the next logging operation.

Command	Description	Reference
CFLOGGET	Acquires the measurement values saved on the Memory Card.	p.61
CFPRFGET	Acquires the profiles saved on the Memory Card.	p.63
CFFORMAT	Initializes the Memory Card.	p.70

EXTERNAL BANK FUNCTIONS

Saving Bank Data to Memory Cards	38
Transferring Bank Data to the Controller	39

Saving Bank Data to Memory Cards

Bank data on Sensor Controllers can be saved on a Memory Card inserted on the Data Storage Unit.

16 sets of bank data on the Sensor Controller are saved to a single file on the Data Storage Unit.

▶ RUN mode-MENU key-[BANK]-[CONT→CF]

Setting value	Description
CH	Selects the channel of the Sensor Controller whose bank data is to be saved. CH2 is not displayed when it is not connected.
File	Selects the bank file number to save to the Memory Card. (BANK0 to 255)

Important

If a file number already containing saved bank settings is selected, those bank settings will be overwritten.

Note

Serial communication commands can be used to save bank data to Memory Cards.



BKCTR2MC command p.65

Transferring Bank Data to the Controller

Bank data stored on Memory Cards can be transferred to the current bank of the specified channel.

▶ RUN mode-MENU key-[BANK]-[CF→CONT]

Setting value	Description
File	Selects the bank file number to transfer. (BANK0 to 255)
CH	Selects the channel of the Sensor Controller at the transfer destination. (1, 2, default value: 1) CH2 is not displayed when it is not connected.

Important

The current settings of the Sensor Controller will be changed. However, if you turn the power OFF without saving the settings, the settings will revert to the original settings before the bank data was transferred. Save the current settings by saving them on the Sensor Controller of the selected channel.

Note

Serial communication commands can be used to transfer bank data to Sensor Controllers.



BKMC2CTR command p.65

SETTING ADDITIONAL FUNCTIONS

Judging Measurement Values (Alarm Outputs)	42
Setting System Conditions	44
Display Settings during Operation	46
Bank Functions	49

Judging Measurement Values (Alarm Outputs)

Specifying Tasks

When outputting the judgment results of measurements as alarms, specify the channel and task to be used for judgment.

► FUN mode-[I/O SET]-[SOURCE]

Setting value	Description
CH	Selects the channel of the Sensor Controller targeted for alarm judgment. (1, 2, default value: 1) CH2 is not displayed when it is not connected.
TASK	Selects the task targeted for alarm judgment. (1-8)

Setting Judgment Conditions

Set the two values, HIGH and LOW thresholds, used for alarm output. Three judgment results are output, [HIGH], [PASS] and [LOW]. Set the judgment conditions in the TEACH mode.

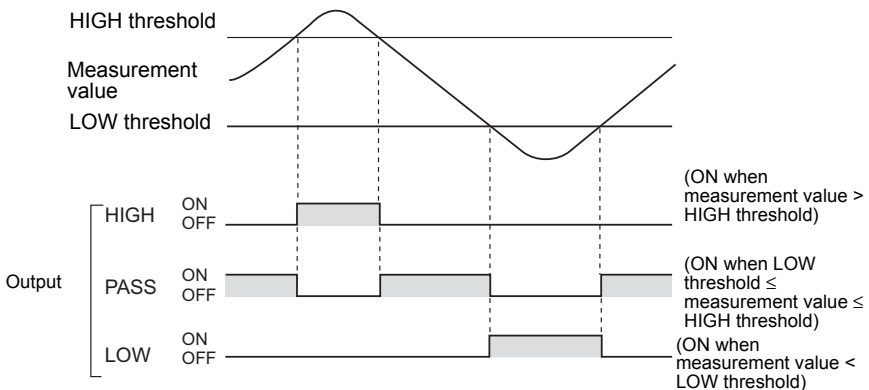

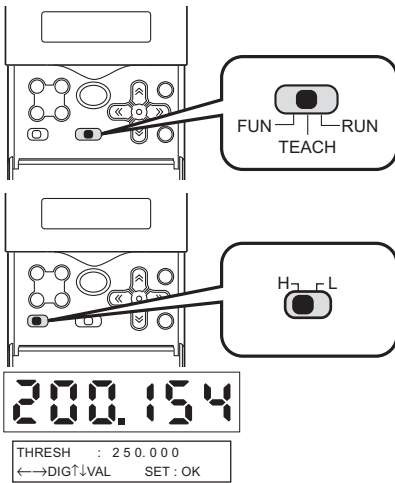

1 Switch to the TEACH mode.

2 Switch the threshold selection switch to H .

3 Set the HIGH threshold.

Note

To change numerical values, use the ↑ key/↓ key, and to change the number of digits use the ← key/→ key.

4 Press the SET key.
The numerical value is applied.

5 Switch the threshold selection switch to L , and set the LOW threshold.

Setting System Conditions

Setting the System Clock

Set the Data Storage Unit's system clock.

► FUN mode-[SYSTEM]-[CLOCK]

Setting value	Description
DATE	Sets the date.
HOUR	Sets the time.

Locking Keys

The keylock disables all key input on the Data Storage Unit. Key input cannot be accepted until the keylock is canceled. This feature is handy for preventing settings from being changed inadvertently. Even during a keylock, however, you can move to the KEYLOCK menu and move between layers of the menu hierarchy with the MENU and ESC keys.

► FUN mode-[SYSTEM]-[KEYLOCK]

Setting value	Description
OFF	Cancels a keylock. (default value)
ON	Locks keys.

Memory Card Operations

Initializing Memory Cards

Initialize the Memory Card.

► FUN mode-[SYSTEM]-[CF]-[FORMAT]

Setting value	Description
OK	Initializes the Memory Card.
CANCEL	Does not initialize the Memory Card.

Removing Memory Cards

For details on removing Memory Cards, see "Inserting and Removing Memory Cards."

 p.20

Changing the Logging Folder Start No.

When a logging file is saved to Memory Card, a folder with a running No. is automatically created. The start No. for this folder can be changed.

Important

Note that when an existing folder No. is specified, the logging data is overwritten.

► FUN mode-[SYSTEM]-[CF]-[FILE No.]

Setting value	Description
0-999	Sets the start No. (default value: current start No.)

Changing the Display Language

Set the display language of the LCD screen.

► FUN mode-[SYSTEM]-[LANGUAG]

Setting value	Description
Japanese	Displays menus in Japanese. (default value)
English	Displays menus in English.

Displaying Data Storage Unit Information

Displays the remaining amount of free space on the Memory Card and the system version of the Data Storage Unit.

► FUN mode-[SYSTEM]-[INFO]

Setting value	Description
CF SIZE	Displays the remaining amount of free space on the Memory Card.
VERSION	Displays the system version of the Data Storage Unit.

Display Settings during Operation

Setting the Digital Display

Set details to be displayed on the Data Storage Unit during logging in the RUN mode. To set the display details, first switch to the RUN mode and then display the top menu.

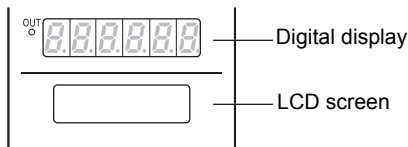

Changing the Number of Display Digits on the Digital Display

Set the number of display digits past the decimal point on the digital display.

Note

When five or less digits are set, the digits are disabled from the rightmost digit first.

▶ RUN mode-MENU key-[DIGITAL]- [DIGIT]

Setting value	Description
0 to 5 (DIGS)	Sets the number of display digits past the decimal point. (default value: 3DIGS)

Hiding the Digital Display

To hide the digital display, select [OFF].

▶ RUN mode-MENU key-[DIGITAL]- [ECO]

Setting value	Description
NORMAL	Displays the digital display at normal brightness. (default value)
ECO	Suppresses current consumption to darken the screen.
OFF	Turns the digital display OFF.

LCD Screen Settings

Hiding the LCD Screen

To hide the LCD screen, select [OFF] or [AUTO OFF].

▶ RUN mode-MENU key-[LCD]-[ON/OFF]

Setting value	Description
ON	Displays the LCD screen at all times. (default value)
AUTOOFF	Hides the LCD screen if the unit has not been operated for one minute.
OFF	Hides the LCD screen at all times. (This operation is enabled in the RUN mode only. Note, however, that the display customize menu is displayed when the MENU key is pressed.)

Turning the LCD Screen Backlight OFF

To turn the LCD screen backlight OFF, select [OFF] or [AUTO OFF].

▶ RUN mode-MENU key-[LCD]-[BACKLIGHT]

Setting value	Description
ON	Turns the LCD screen backlight ON at all times. (default value)
AUTOOFF	Turns the LCD screen backlight OFF if the unit has not been operated for one minute.
OFF	Turns the LCD screen backlight OFF.

Changing the LCD Screen Display Details

Customized characters can be displayed on the LCD screen.

► RUN mode-MENU key-[LCD]-[CUSTOM]

Setting value	Description
ON/OFF	Set this item to ON to display characters set by [CUSTOM] on the LCD screen. (default value: OFF)
CUSTOM	<p>Edits the characters to display in the LCD screen. (max. 16 digits)</p> <ul style="list-style-type: none"> •Call up the first characters of each character group with function keys 1 to 4. <p>1: A to Z, [, \,], ^, _ , `</p> <p>2: a to z, {, , }, →, ←, °, 「, 」, * , フ, ア, イ, ウ, エ, オ, ヤ, ユ, ヨ, ツ, ー</p> <p>3: ア to ン, °, °, space, !, ", #, \$, %, &, ', (,), *, +, -, ., /</p> <p>4: 0 to 9, :, ;, <, =, >, ?, @</p> <ul style="list-style-type: none"> •Select the characters in order by the UP/DOWN keys. •Move the digit by the L/R keys. •To delete a character, select space.

Bank Functions

Up to four setups can be stored on the Data Storage Unit, and these can be switched when setting up the unit. A set of these settings is called a "bank."

Switching Banks

Bank 1 is selected as the default. However, other banks 2 to 4 can be selected.

► FUN mode-[BANK]-[CHANGE]

Setting value	Description
BANK1, BANK2, BANK3, BANK4	Selects the target bank. (default value: BANK1)

Note

Serial communication commands can be used to switch banks from an external device.



Switch Bank <BANKSET command> p.69

Clearing Banks

The content of the currently selected bank is cleared.

► FUN mode-[BANK]-[CLEAR]

Important

[SYSTEM] settings and the display details in the RUN mode are not cleared.

COMMUNICATION WITH EXTERNAL DEVICES

List of Output Data	52
Communication Using I/O Signals	53
Timing Charts	56
Serial Communication	58

List of Output Data

The Data Storage Unit can output judgment values to external devices. Use of serial communication enables measurement values to be output.

Judgment value

Output path	Description
Controller I/O cable	Captures the measurement results of tasks specified at [I/O SET], and outputs the results of judging the judgment conditions on the Data Storage Unit.

Measurement value

Output path	Description
Serial communication	The measurement values of the specified task are output by the MEASURE command.

Communication Using I/O Signals

Using the Controller I/O Cable

By using the Data Storage Unit's I/O cable, you can output judgment results to external devices, or input a control signal from external devices. A predetermined I/O signal is assigned to each signal wire of the I/O cable.

Wiring

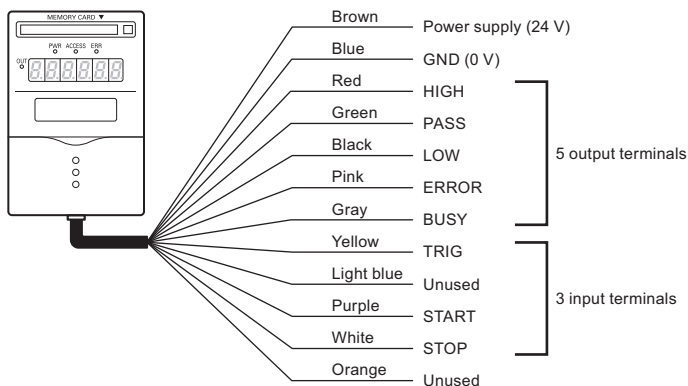

Assignments and Functions of I/O Signal Wires

Assignment of output signal wires

Function	Signal	Description
Judgment output	HIGH	Turns ON when the measurement value of the specified task is greater than the HIGH threshold.
	PASS	Turns ON when $\text{LOW threshold} \leq \text{measurement value} \leq \text{HIGH threshold}$.
	LOW	Turns ON when the measurement value of the specified task is smaller than the LOW threshold.
	ERROR	Turns ON when specified task ends in a measurement error.
Control output	BUSY	Turns ON while the Data Storage Unit is executing processing. New operation instructions cannot be accepted while the BUSY signal is ON.

Assignment of input signal wires

Function	Signal	Description
Logging start	START	Starts logging.
Logging end	STOP	Ends logging.
Logging trigger	TRIG	When the logging condition is set to [TRIGGER], data during input of the TRIG signal is logged and saved.

I/O Circuit Diagrams

NPN type (ZG2-DSU11)

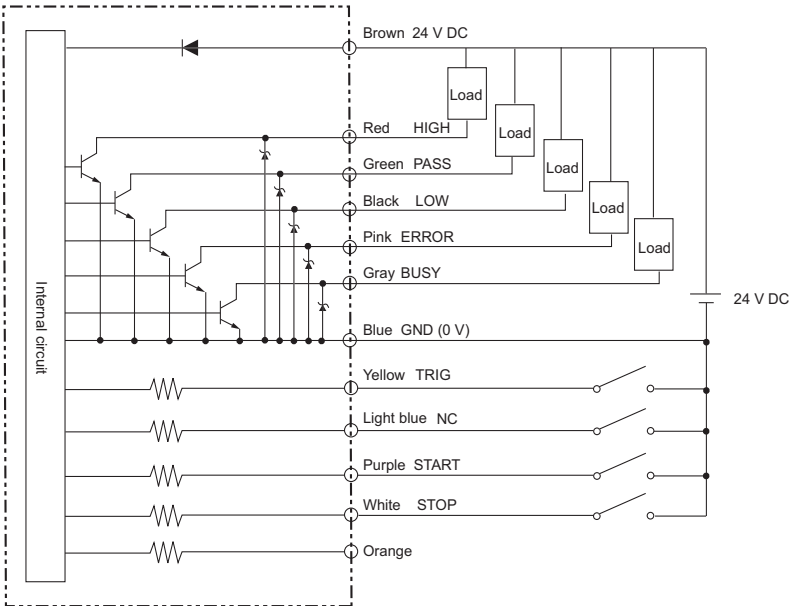

NPN type (ZG2-DSU41)

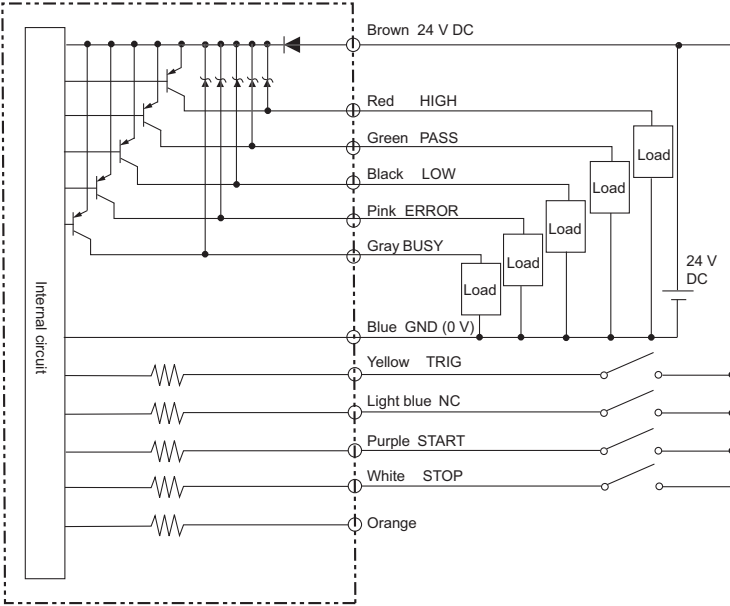

Timing Charts

This section explains the timing charts of the I/O signals that are exchanged between the Data Storage Unit and external devices.

Logging

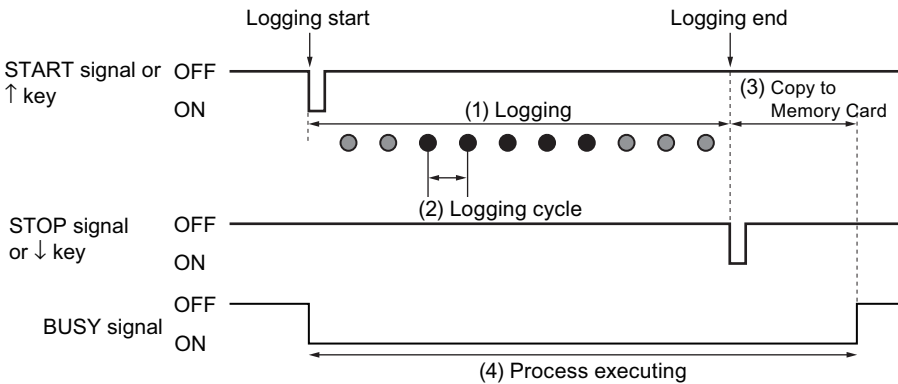

Process	Description
(1) Logging	Data that matches preset conditions is logged to internal memory on the Data Storage Unit.
(2) Logging cycle	The measurement cycle of the Sensor Controller is the logging cycle.
(3) Copy to Memory Card	Logged data is automatically copied to the Memory Card after logging ends. Approximate copying times are as follows: •Profiles: Approx. 250 ms x number of profiles •Measurement values: Approx. 400 ms + (7ms x number of profiles)
(4) Process executing	The BUSY signal turns ON while the Data Storage Unit is executing processing. New operation instructions cannot be accepted while the BUSY signal is ON.

When the Data Storage Unit is connected, the measurement cycle of the Sensor Controllers increases according to the display mode of the Sensor Controller.

- Profile display: approx. 150 to 300 ms (varies according to profile shape)
- Digital display: approx. 50 ms per displayed task (i.e. approx. 200 ms when four tasks are displayed)

To set the fastest measurement cycle, use the Sensor Controllers with the display OFF (ECO monitor).

Transferring Bank Data

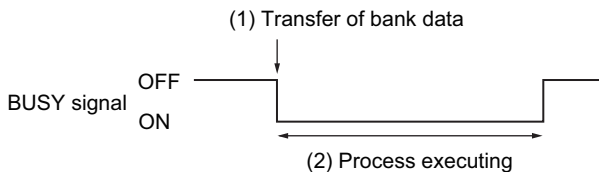

Process	Description
(1) Transfer of bank data	Bank data is transferred between the Sensor Controller and Data Storage Unit. Transfer operation is performed by using serial communication commands or menu operations.
(2) Process executing	During transfer of bank data, the BUSY signal is turned ON. New operation instructions cannot be accepted while the BUSY signal is ON.

Alarm Output

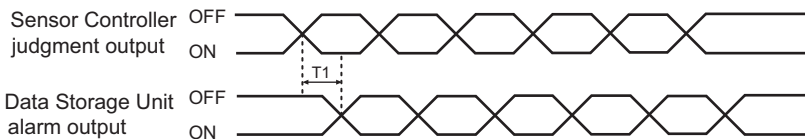

Process	Description
T1: Alarm output delay time	This is the delay time from when the measurement value is applied on the Sensor Controller up to output of the alarm on the Data Storage Unit. 1 ms or less

Serial Communication

You can use the USB port or RS-232C connector of the Data Storage Unit to perform serial communication with external devices such as a personal computer.

Serial communication functions in the RUN mode. Serial communication functions are not available in the FUN mode or TEACH mode.

RS-232C Specifications

Connecting a PC

For details how to connect to a PC using the USB/RS-232C cable, refer to the ZG2 series User's Manual.

Note

Installation of the USB driver is necessary only when connecting an external device to the USB interface for the first time. For the USB driver, use the exclusive USB driver packaged with the ZG2-WDC_1A sensor controller.

Setting Communication Specifications

Set the RS-232C communication specifications. Match the communications settings on the Data Storage Unit with those on the Sensor Controller.

► FUN mode-[SYSTEM]-[COM]

Setting value		Setting range
RS-232C	LENGTH	8BIT, 7BIT (default value: 8BIT)
	PARITY	NONE, ODD, EVEN (default value: NONE)
	STOP	1BIT, 2BIT (default value: 1BIT)
	BAUDRAT	9600, 19200, 38400, 57600, 115200 (default value: 38400)
	DELIMIT	CR, LF, CR+LF (default value: CR)
NODE	0 to 16 (default value: 0)	

Note

This "node No." sets the connection group No. as seen from the host device (PLC). Not only the ZG2 series but also multiple devices can be connected to the PLC. The node No. assigned to devices connected to a PLC in this instance is referred to as a node No.

Communication Commands

Command/Response Format

<Command>

Command data	Delimiter
--------------	-----------

<Response>

When processing ends successfully

Response data	Delimiter
---------------	-----------

O	K	Delimiter
---	---	-----------

When processing fails

E	R	Delimiter
---	---	-----------

Command data	Specifies the command and parameters.
Response data	Stores the acquired data.
Delimiter	This control code indicates the end of the data.

Configuration of measurement value data

Acquired measurement values are output as a data structure of variable length of up to 12 characters (when the number of digits past the decimal point is set to 5) including delimiters and sign.

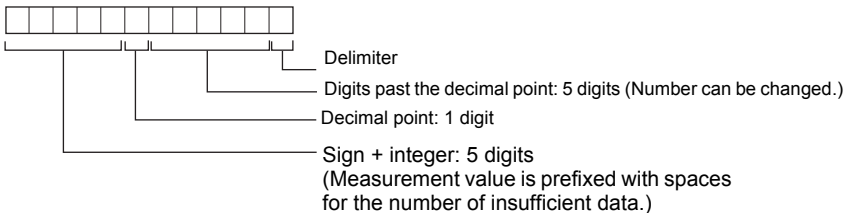

Sign	The sign (+, -) of the measurement value is stored.
Integer	When the integer section of the measurement value is less than 3 characters, it is prefixed with spaces for the number of insufficient data. When the number of digits past the decimal point is reduced, the length of the text string decreases proportionately.
Decimal point	<p><Measurement value> <Data configuration></p> <p>+12.34567 <input type="text"/> <input type="text"/> + 1 2 . 3 4 5 6 7 <input type="text"/> <input type="text"/> CR Number of digits past the decimal point: 5</p>
Digits past the decimal point	<p>+12.34567 <input type="text"/> <input type="text"/> + 1 2 . 3 <input type="text"/> <input type="text"/> CR Number of digits past the decimal point: 1</p> <p>-0.00123 <input type="text"/> <input type="text"/> - 0 . 0 0 1 <input type="text"/> <input type="text"/> CR Number of digits past the decimal point: 3</p> <p>At measurement error <input type="text"/> <input type="text"/> - 9 9 9 . 9 9 9 9 9 <input type="text"/> <input type="text"/> CR</p>

Available Commands

Measurement value acquisition/profile acquisition commands

Command name	Description	Reference
CFLOGGET	Acquires the measurement values saved on the Memory Card.	p.61
CFPRFGET	Acquires the profiles saved on the Memory Card.	p.63
MEASURE (or M)	Acquires measurement values set at [I/O SET].	p.64

Bank data transfer command

Command name	Description	Reference
BKMC2CTR	Transfers bank data stored on the Memory Card to the Sensor Controller.	p.65
BKCTR2MC	Saves bank data on the Sensor Controller to the Memory Card.	p.65

Setting acquisition/change commands

Command name	Description	Reference
DATAGET	Acquires the setup data on the Data Storage Unit.	p.66
DATASET	Changes the setup data on the Data Storage Unit.	p.66
DATASAVE	Saves all bank data to the Data Storage Unit's flash memory.	p.67
VERGET	Acquires the version information system.	p.67
CHGET	Acquires the number of connected Data Storage Units.	p.68

Bank Control Commands

Command name	Description	Reference
BANKGET	Acquires the current bank No.	p.69
BANKSET	Switches to the specified bank No.	p.69

Utility commands

Command name	Description	Reference
CFFORMAT	Initializes the Memory Card.	p.70

Measurement Value Acquisition/Profile Acquisition Commands

Acquire Logged Measurement Value <CFLOGGET command>

This command acquires the measurement values saved on the Memory Card. All measurement values saved to the specified folder are output.

Important

This command can be used only when the Data Storage Unit is connected with the USB cable.

<Command format>

C	F	L	O	G	G	E	T					C _R
---	---	---	---	---	---	---	---	--	--	--	--	----------------

Folder No.
(max. 3 digits)

Example: To acquire the measurement values stored to folder No. 1

C	F	L	O	G	G	E	T	0	0	1	C _R
---	---	---	---	---	---	---	---	---	---	---	----------------

<Response format>

When processing ends successfully

Acquisition time	Measurement value of CH1 task 1	,	•••	,	Measurement value of CH2 task 8	CR
------------------	---------------------------------	---	-----	---	---------------------------------	----

Acquisition time	Measurement value of CH1 task 1	,	Measurement value of CH1 task 2	,	•••	,	Measurement value of CH2 task 8	CR
------------------	---------------------------------	---	---------------------------------	---	-----	---	---------------------------------	----

:

Acquisition time	Measurement value of CH1 task 1	,	Measurement value of CH1 task 2	,	•••	,	Measurement value of CH2 task 8	CR
------------------	---------------------------------	---	---------------------------------	---	-----	---	---------------------------------	----

OKCR



Configuration of measurement value data p.59

When processing fails

- When there is no data corresponding to the specified folder No.

NOFILECR

- When the Memory Card is not inserted

NODIRCR

<Explanation of parameters>

Folder No.	Specify the folder No. with a 3-digit number.
Acquisition time	This time is output in the format "hh:mm:ss".
Measurement value	The acquired measurement value is returned. Only the tasks that are set are output.

Acquire Measurement Value <MEASURE command>

This command acquires measurement values set at [I/O SET].

<Command format>

MEASURE^{CR} or M^{CR}

<Response format>

When processing ends successfully

Measurement value^{CR}

OK^{CR}

When processing fails

ER^{CR}

<Explanation of parameters>

Measurement value	Measurement values set at [I/O SET] are acquired.
-------------------	---

Setting Acquisition/Change Commands

Acquire Setup Data <DATAGET command>

This command acquires the setup data on the Data Storage Unit.

<Command format>

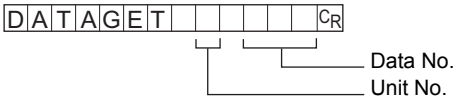

<Response format>

When processing ends successfully

DATA C_R

When processing fails

ER C_R

Note

For details on parameters, see "Parameter List (p.71)."

Change Setup Data <DATASET command>

This command changes the setup data on the Data Storage Unit.

<Command format>

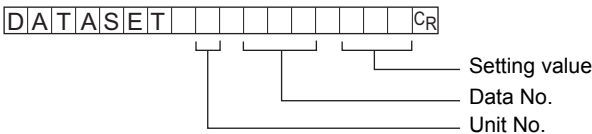

<Response format>

When processing ends successfully

OK C_R

When processing fails

ER C_R

Note

For details on parameters, see "Parameter List (p.71)."

Save All Bank Data on the Data Storage Unit <DATASAVE command>

This command saves all bank data to the Data Storage Unit's flash memory.

<Command format>

D A T A S A V E C R

<Response format>

When processing ends successfully

O K C R

When processing fails

E R C R

Acquire Version No. <VERGET command>

This command acquires the version information system.

<Command format>

V E R G E T C R

<Response format>

When processing ends successfully

Z G 2 - D S U X . X X X C R

Version No.

When processing fails

E R C R

Bank Control Commands

Acquire Bank No. <BANKGET command>

This command acquires the current bank No.

<Command format>

BANKGETCR

<Response format>

When processing ends successfully

CR

Bank No. (max. 1 digit)

When processing fails

ERC

<Explanation of parameters>

Bank No.	The acquired bank No. is returned. (1 - 4)
----------	--

Switch Bank <BANKSET command>

This command switches to the specified bank No.

<Command format>

BANKSET CR

Bank No.

<Response format>

When processing ends successfully

OKCR

When processing fails

ERC

<Explanation of parameters>

Bank No.	Specifies the bank No. after the bank is switched. (1 - 4)
----------	--

Utility Commands

Initialize Memory Card <CFFORMAT command>

This command initializes the Memory Card.

<Command format>

```
CFFORMATCR
```

<Response format>

When processing ends successfully

```
OKCR
```

When processing fails

```
ERCR
```

Parameter List

Parameters Common to the DATAGET/DATASET Commands

Targets for acquiring measurement values from

Parameter	Unit No.	Parameter No.	Measurement value/ acquisition value
Measurement value of CH1 task 1	0	16	0: OFF, 1: ON
Measurement value of CH1 task 2		17	
Measurement value of CH1 task 3		18	
Measurement value of CH1 task 4		19	
Measurement value of CH1 task 5		20	
Measurement value of CH1 task 6		21	
Measurement value of CH1 task 7		22	
Measurement value of CH1 task 8		23	
Measurement value of CH2 task 1	1	16	0: OFF, 1: ON
Measurement value of CH2 task 2		17	
Measurement value of CH2 task 3		18	
Measurement value of CH2 task 4		19	
Measurement value of CH2 task 5		20	
Measurement value of CH2 task 6		21	
Measurement value of CH2 task 7		22	
Measurement value of CH2 task 8		23	

Logging triggers

Parameter	Unit No.	Parameter No.	Measurement value/ acquisition value
Logging condition	3	0	0: MEAS, 1: TRIGGER, 2: TIME, 3: POINT
Channels targeted by measurement result trigger	3	4	0: CH1, 1: CH2
Measurement results targeted by measurement result trigger	3	6	0: ALL, 1: NG+ERR, 2: NG, 3: ALL-PASS
Number of data points specification	3	10	1 to 99999

Profile logging

Parameter	Unit No.	Parameter No.	Measurement value/ acquisition value
Logging target	23	0	0: OFF, 1: CH1, 2: CH2

Judgment outputs

Parameter	Unit No.	Parameter No.	Measurement value/ acquisition value
Tasks targeted by alarm output	40	0	Task No.-1 (0 to 7)
CH targeted by alarm output	40	1	0: CH1, 1: CH2
Alarm output threshold lower limit	40	2	-999999999 to 999999999(*1)
Alarm output threshold upper limit	40	3	

*1: Digits past the decimal point cannot be handled by the DATAGET/DATASET commands. Input as follows:

Example: -999.999999 to 999.999999 → -999999999 to 999999999

APPENDICES

Specifications and External Dimensions	74
Error Messages and Corrective Actions	77
Menu List	79
Basic Knowledge for Operation	81
Updating the Firmware	83
INDEX	85

Specifications and External Dimensions

Data Storage Unit

Specifications

Item		ZG2-DSU11	ZG2-DSU41	
I/O type		NPN	PNP	
Number of connected Sensor Controllers		2 (*1)		
Applicable Sensor Controllers		ZG2-WDC11/WDC41		
External I/F	I/O signal wire	Logging start/end input	ON: Short-circuited with 0 V or 1.5 V max., OFF: Open (leakage current 0.1 mA max.)	ON: Supply voltage short-circuited or supply voltage -1.5 V max. OFF: Open (leakage current 0.1 mA max.)
		Judgment output (HIGH/PASS/LOW/ERROR)	NPN open collector, 30 VDC, 50 mA max. Residual voltage 1.2 V max.	PNP open collector 50 mA max. Residual voltage 1.2 V max.
	Serial I/O	USB2.0	1 port, FULL SPEED [12 Mbps], MINI-B	
		RS-232C	1 port, max. 115,200 bps	
Function	Number of logging data (*2)	Main memory	Max. number of profile saves: 5,120 Max. number of measurement value saves: 65,000 (*3)	
		Memory Card (256 MB) (*4)	Max. number of profile saves: 35,328 256 saves x 138 files) Max. number of measurement value saves: 7.15 million (65,000 saves x 110 files)	
	Logging triggers		External triggers, data triggers (self trigger), time trigger	
	External bank functions		4096banks (16 banks x 256 files) (*5)	
	Other functions		Alarm output functions	

Item		ZG2-DSU11	ZG2-DSU41
Ratings	Power supply voltage	21.6 V to 26.4 VDC (including ripple)	
	Current consumption	0.5 A or less	
Operation environment robustness	Ambient temperature range	Operating: 0 to 50°C Storage: 0 to 60°C (with no icing or condensation)	
	Ambient humidity range	Operating and storage: 35% to 85% (with no condensation)	
Material		Case: polycarbonate (PC)	
Cable length		2 m	
Minimum bending radius		52 mm	
Weight		Approx. 280 g (excluding packing materials and accessories)	
Accessories		Ferrite core (1 p'ce), Instruction Sheet	

*1: The Controller Link Unit is needed for gang-mounting.

*2: During logging, data is saved to main memory and is automatically written to the Memory Card at the end of logging. The possible number of logs varies according to the setting conditions.



Possible Number of Logging Data p.28

*3: Measurement values can be saved up to 65,000 times even when two Sensor Controllers are connected and eight tasks are being measured on each controller.

*4: This is the maximum number of saves when logging is performed under the following conditions:

- One task is measured on one Sensor Controller.
- Only profiles or measurement values are logged.

*5: A Memory Card of capacity of at least 128 MB is required.

External Dimensions

(Unit: mm)

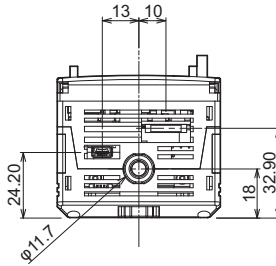
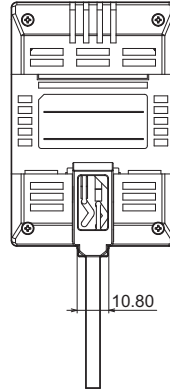
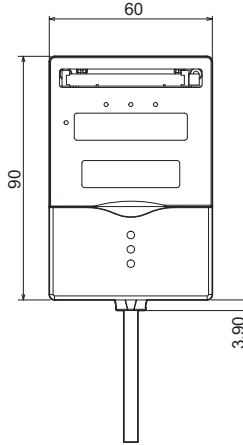
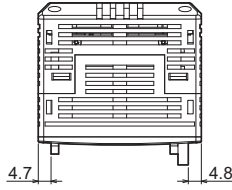
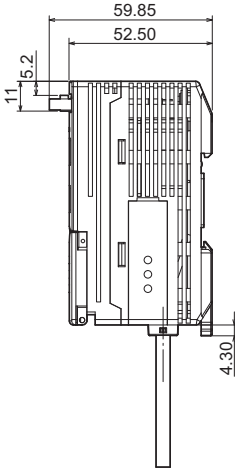

Error Messages and Corrective Actions

The following shows error messages that are displayed on the LCD screen and their corrective actions.

Error message		
Display details	Cause	Remedy
SYSTEM ERROR BANK DATA	Internal bank data is in error.	Hold down the ↑ key for 3 seconds, and then hold down the ↓ key for 3 seconds. After initialization ends, turn the power OFF then back ON again to restore the unit.
SYSTEM ERROR CONNECT	The Sensor Controller is not connected.	Connect the Sensor Controller.
SYSTEM ERROR MAIN COM	Internal error	Turn the unit OFF then back ON again.
File not found	The specified bank file does not exist on the Memory Card.	Change the bank file number to an existing file name.
Setting failed	The specified setting value is out of range.	Set within the allowable setting range.
Data error	The specified bank file is in error.	Select the correct bank file.
Transfer failed	Bank file communication error	Check the connection between Sensor Controllers.
Dead Battery	The clock backup battery has run down.	Please contact your OMRON sales representative.
Disp range Error	The measurement results exceed the displayed number of digits.	Change the number of digits past the decimal point setting.
NO MEDIA	The Memory Card is not inserted.	Insert the Memory Card.
Insufficient	There is not enough remaining space on the Memory Card.	<ul style="list-style-type: none"> •Replace the Memory Card. •Delete unwanted files from the Memory Card. •Format the Memory Card.

Glossary

Term	Explanation
Memory Card	Media for saving and storing logging data. The Data Storage Unit uses compact flash cards.
CSV file	CSV stands for "Comma Separated Values". CSV files are documents containing individual data elements separated by a comma as their delimiter. CSV files can be browsed in generally available spreadsheet software.

Menu List

FUN Mode

This mode is for setting the logging conditions.

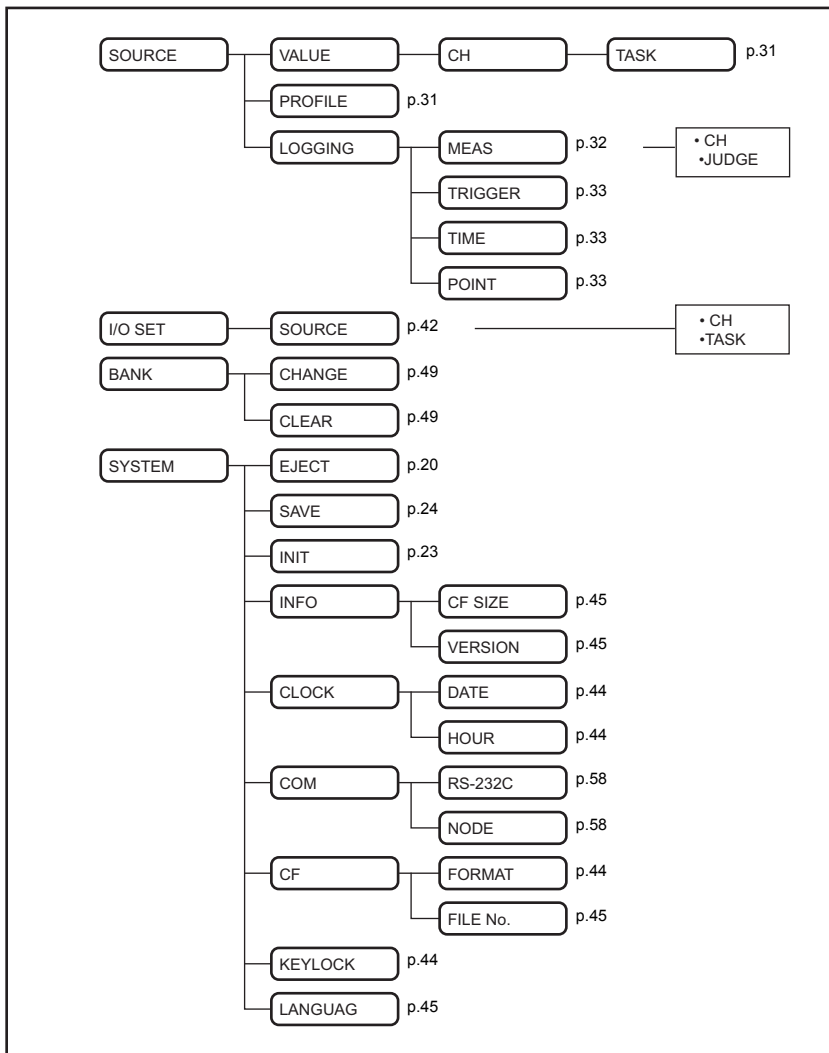

RUN Mode

This mode is for executing logging. It is also for setting up the content of the digital display and other display-related settings, and for making settings when using Memory Cards as an external bank.

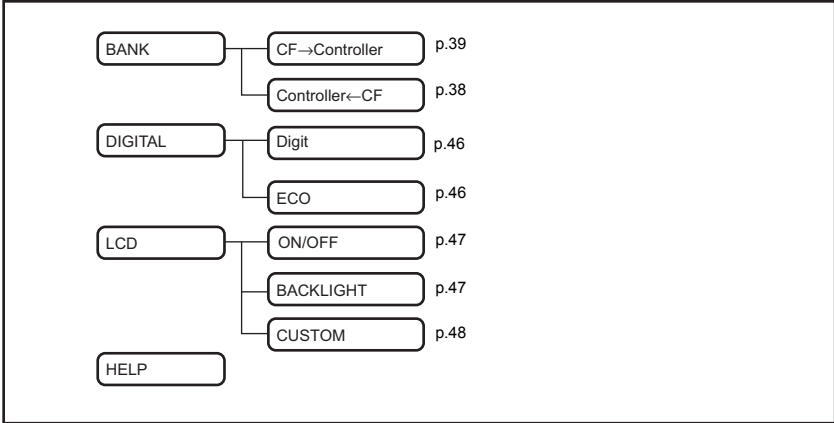

TEACH Mode

This mode is for setting alarm output thresholds.

Basic Knowledge for Operation

How to Select Menu

Select items displayed on the LCD screen directly with the functions keys.

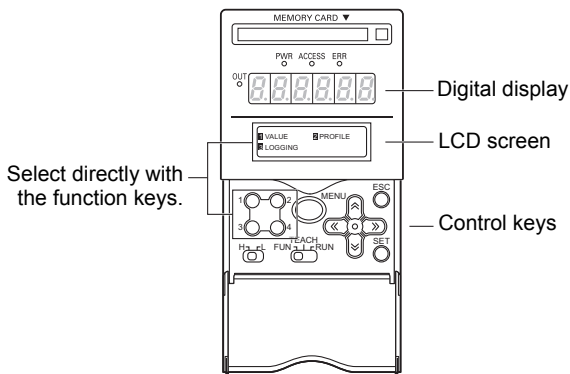

Digital display







Menu setting items are displayed using the following alphabet characters.

Correspondence between alphabet

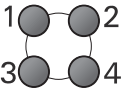
A	B	C	D	E	F	G	H	I
A	b	c	d	E	F	G	h	I
J	K	L	M	N	O	P	Q	R
J	K	L	M	N	O	P	Q	R
S	T	U	V	W	X	Y	Z	
S	T	U	V	W	X	Y	Z	

List of Key Operations

Key functions differ according to the currently selected mode.

Key		FUN mode	RUN mode		TEACH mode
			During setup	During measurement	
Function keys		These keys directly set the No. preceding the items displayed on the LCD screen.	These keys can be used as a substitute for the TRIG signal. (*1)	-	
← LEFT key → RIGHT key		The functions of these keys differ according to the set content. <ul style="list-style-type: none"> • Scrolls the page. s • Selects the digit of numerical values. 	Switches the content displayed on the digital display.	Select the digit of the threshold numerical value.	
↑ UP key ↓ DOWN key		The functions of these keys differ according to the set content. <ul style="list-style-type: none"> • Changes numerical values. • Changes characters. 	↑ UP key: Starts logging. ↓ UP key: Ends logging.	Changes the digit of the threshold numerical value.	
MENU/VIEW key		Returns to the top menu.	Displays the display customize menu.	-	
SET key		Applies the item you are setting up.	-	Applies the item you are setting up.	
ESC key		Returns to the previous menu.	-	Cancels the threshold you are setting up.	

*1: These keys can be used as a substitute for the TRIG signal when the logging condition is set to [TRIGGER]. Logging is also performed while function key 1 is held down.

Updating the Firmware

Update the firmware by connecting the Data Storage Unit to the PC with the USB cable and using Warp Engine Zero.

For the firmware update and Warp Engine Zero, please contact your OMRON representative.

The update procedure is the same as that for the Sensor Controller. Refer to the Sensor Controller User's Manual.

Important

- During a firmware update, do not turn the Data Storage Unit OFF. Doing so will prevent the Data Storage Unit from functioning normally.
- When installing Smart Monitor and the USB driver on a PC, log in as an administrator or a user having the same privileges as a computer administrator for changing system settings.

INDEX

A

Assignment	
I/O cable	53

B

Bank	
Clearing	49
Switching	49
BANKGET command	69
BANKSET command	69
BKCTR2MC command	65
BKMC2CTR command	65

C

CFFORMAT command	70
CFLOGGET command	61
CFPRFGET command	63
CH number	18
CHGET command	68
Command format	59
Communication commands	59
Connecting the Power Supply	19
Control keys	15, 81
Controller Link Unit	
Gang-mounting	18

D

Data Storage Unit	
External dimensions	76
Name	15
Specifications	74
DATAGET command	66
DATASAVE command	67
DATASET command	66
Digital display	46
Hiding	46
Number of display digits	46
Display language	45

E

ECO setting	47
External bank	22
Saving	38
Transferring	39

F

Ferrite core	19
Format	30
FUN mode	79

G

Gang-mounting	18
---------------	----

I

I/O circuit diagrams	54
Initialization	23

J

Judgment conditions	42
---------------------	----

K

Keylock	44
---------	----

L

LCD screen	46, 47, 81
Backlight	47
Display details	48
Hiding	47
List of commands	60
List of Key Operations	82
Logging	22

Conditions	32
Ending	34
How it works	27
Measurement value	31
Number of Data	28
Procedure	26
Profile	31
Starting	34

V

VERGET command	67
----------------	----

W

Wiring	53
--------	----

M

MEASURE command	64
Memory Card	20, 35, 44
File No.	45
Folder structure	29
Initializing	44

N

NODE	58
------	----

O

Output data	52
-------------	----

R

Response format	59
RS-232C	58
RUN mode	80

S

Save	24
Serial communication	35, 58
System clock	44
System Configuration	14

T

TEACH mode	80
Threshold	42
Timing charts	56

MEMO

Revision History

A manual revision code appears as a suffix to the catalog number at the bottom of the front and back covers of this manual.

Cat. No. Z289-E1-02

↑
Revision code

Revision code	Revision date	Revised content
01	December 2008	First edition
01A	March 2012	Additions for Notice for Korea Radio Law
02	August 2015	Additions corresponding to change of EN standard

OMRON Corporation Industrial Automation Company
Kyoto, JAPAN

Contact: www.ia.omron.com

Regional Headquarters

OMRON EUROPE B.V.

Sensor Business Unit

Carl-Benz-Str. 4, D-71154 Nufringen, Germany
Tel: (49) 7032-8111-0/Fax: (49) 7032-811-199

OMRON ELECTRONICS LLC

2895 Greenspoint Parkway, Suite 200
Hoffman Estates, IL 60169 U.S.A.
Tel: (1) 847-843-7900/Fax: (1) 847-843-7787

OMRON ASIA PACIFIC PTE. LTD.

No. 438A Alexandra Road # 05-05/08 (Lobby 2),
Alexandra Technopark,
Singapore 119967
Tel: (65) 6835-3011/Fax: (65) 6835-2711

OMRON (CHINA) CO., LTD.

Room 2211, Bank of China Tower,
200 Yin Cheng Zhong Road,
PuDong New Area, Shanghai, 200120, China
Tel: (86) 21-5037-2222/Fax: (86) 21-5037-2200

Authorized Distributor:

© OMRON Corporation 2008 All Rights Reserved.
In the interest of product improvement,
specifications are subject to change without notice.

Cat. No. Z289-E1-02

0815